

HELM

ZHL516.X















Batteria lavabo a 3 fori bocca alta. / 3 hole basin mixer.



Batteria lavabo a 3 fori bocca alta in acciaio inox AISI 316L, con aeratore, flessibili di collegamento, senza scarico.

3 hole basin mixer in AISI 316L stainless steel, high spout with aerator, flexible tails, without pop-up waste.

Finiture / Finishes

 X Acciaio inox spazzolato / Brushed stainless steel	 XG2 Acciaio inox spazz.-godr. verticale / Br. stainless steel - Vertical knurling	 XG3 Acciaio inox spazz.-godronatura diagonale / Br. stainless steel-diagonal knurling	 XP31 Brushed PVD British gold / -	 XP31G2 Br. PVD British gold-godr. diagonale / Br. PVD British gold-vertical knurling	 XP31G3 Br. PVD British gold-godr. diagonale / Br. PVD British gold-diagonal knurling	 XP41 Brushed PVD gold / Brushed PVD gold	 XP41G2 Br. PVD gold-godronatura verticale / Brushed PVD gold-vertical knurling
 XP41G3 Br. PVD gold-godr. diagonale / Br. PVD gold-diagonal knurling	 XP81 PVD Brushed Total Black / PVD Brushed Total Black	 XP81G2 Br. PVD Total Black-godr. verticale / Br. PVD Total Black-vertical knurling	 XP81G3 Br. PVD Total Black-godr. diagonale / Br. PVD Total Black-diagonal knurling	 XP91 Brushed PVD copper / Brushed PVD copper	 XP91G2 Br. PVD copper-godr. verticale / Br. PVD copper-vertical knurling	 XP91G3 Br. PVD copper-godr. diagonale / Br. PVD copper-diagonal knurling	

HELM

ZHL516.X

Disegno Complessivo / Overall Drawing

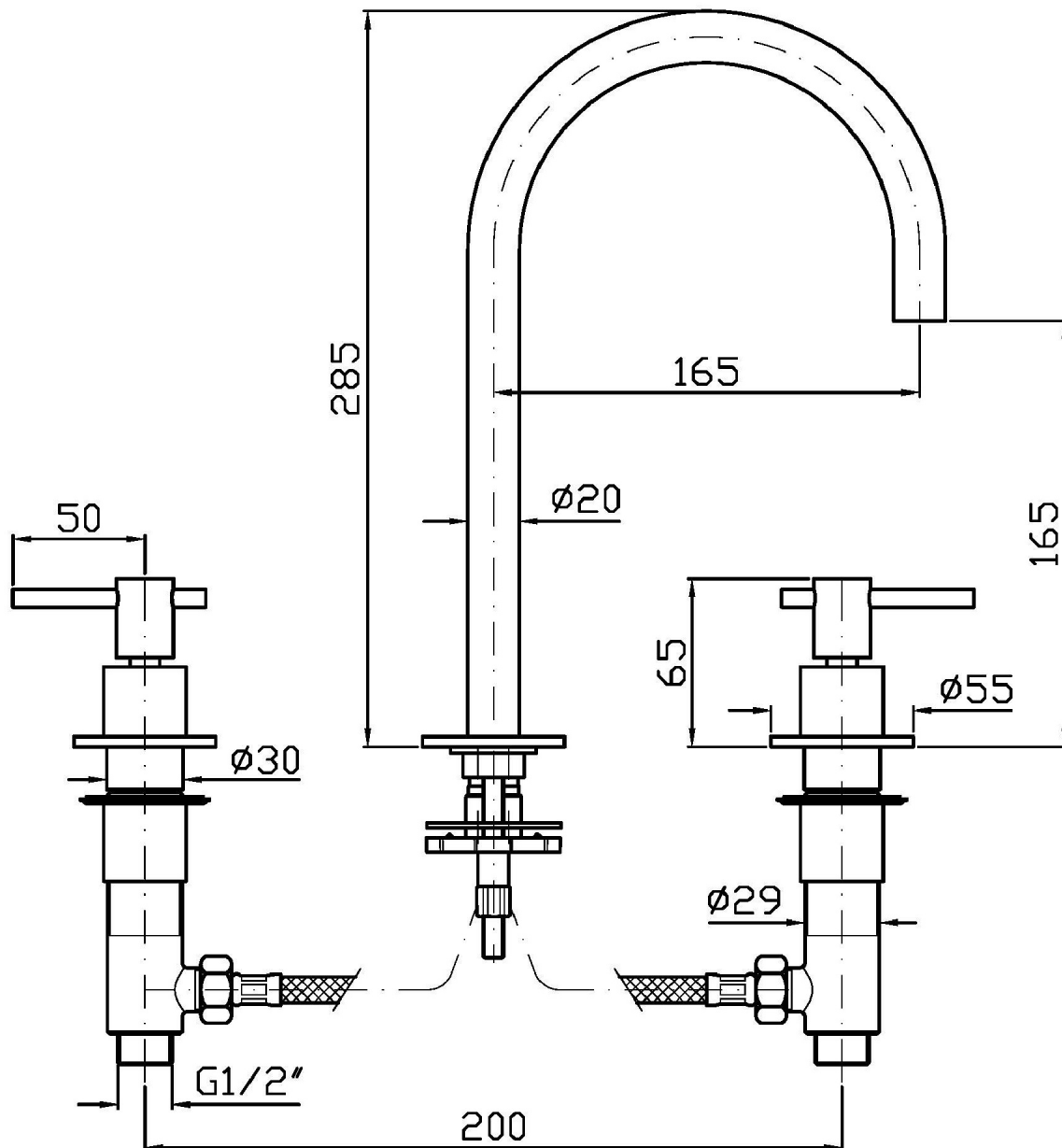

HELM

ZHL516.X Portate / Flowrates (lt/min)

PRESSIONE PRESSURE	1 BAR	2 BAR	3 BAR	4 BAR	5 BAR
P1 LAVABO BASIN	3,9	4,6	4,8	4,9	5
P2					
P3					
P4					
P5					

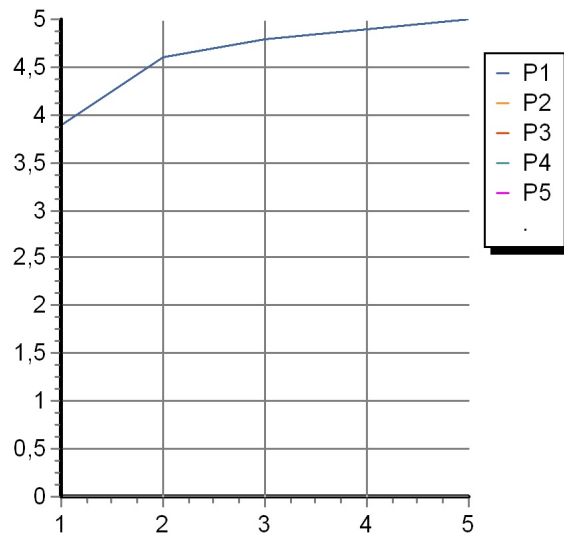

HELM

ZHL516.X Pesì e Misure / Weights and Sizes

Peso (Kg) Weight (lb)	2,90 (Kg)	6,39 (lb)
Volume test (dc3) - (in3)	11,01 (dc3)	671,87 (in3)
h (mm) - (in)	90,00 (mm)	3,54 (in)
L1 (mm) - (in)	335,00 (mm)	13,19 (in)
L2 (mm) - (in)	365,00 (mm)	14,37 (in)

