

Marchio / Brand ZUCCHETTI

Classe / Class INOX

## HELM

ZHL695.X

Gruppo incasso vasca-doccia. / 3 hole built-in bath-shower mixer.



Gruppo incasso vasca-doccia a 3 fori, in acciaio inox AISI 316L, con deviatore a 2 vie.











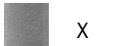
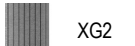



3 hole built-in bath-shower mixer in AISI 316L stainless steel, with 2 way diverter.

R99508



Parte incasso. / Built-in part.

## Finiture / Finishes

 X Acciaio inox spazzolato / Brushed stainless steel	 XG2 Acciaio inox spazz.-godr. verticale / Br. stainless steel - Vertical knurling	 XG3 Acciaio inox spazz.-godronatura diagonale / Br. stainless steel-diagonal knurling	 XP31 Brushed PVD British gold / -	 XP31G2 Br. PVD British gold-godr. diagonale / Br. PVD British gold-vertical knurling	 XP31G3 Br. PVD British gold-godr. diagonale / Br. PVD British gold-diagonal knurling	 XP41 Brushed PVD gold / Brushed PVD gold	 XP41G2 Br. PVD gold-godronatura verticale / Brushed PVD gold-vertical knurling
 XP41G3 Br. PVD gold-godr. diagonale / Br. PVD gold-diagonal knurling	 XP81 PVD Brushed Total Black / PVD Brushed Total Black	 XP81G2 Br. PVD Total Black-godr. verticale / Br. PVD Total Black-vertical knurling	 XP81G3 Br. PVD Total Black-godr. diagonale / Br. PVD Total Black-diagonal knurling	 XP91 Brushed PVD copper / Brushed PVD copper	 XP91G2 Br. PVD copper-godr. verticale / Br. PVD copper-vertical knurling	 XP91G3 Br. PVD copper-godr. diagonale / Br. PVD copper-diagonal knurling	

## HELM

ZHL695.X

Disegno Complessivo / Overall Drawing

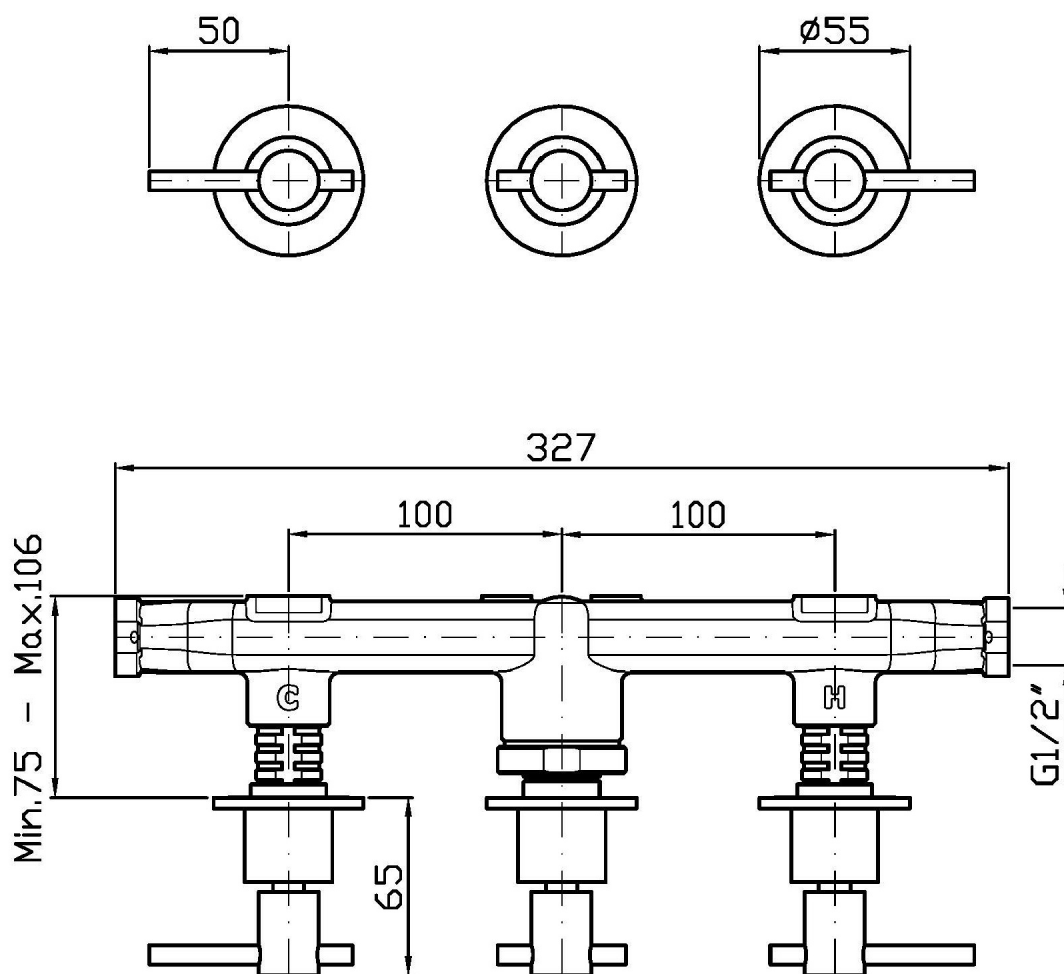

## HELM

### ZHL695.X Portate / Flowrates (lt/min)

PRESSIONE PRESSURE	1 BAR	2 BAR	3 BAR	4 BAR	5 BAR
DEVIATORE <i>P1</i>	10,5	15,3	19	21,6	24
<i>P2</i>					
<i>P3</i>					
<i>P4</i>					
<i>P5</i>					

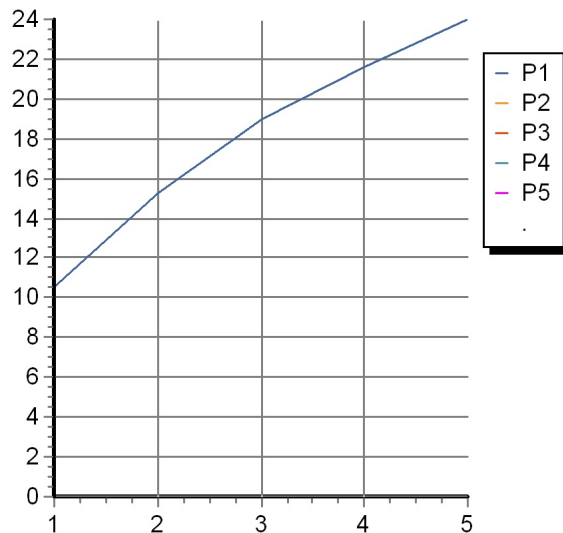

## HELM

### ZHL695.X Pesì e Misure / Weights and Sizes

Peso ( Kg ) Weight ( lb )	1,50 ( Kg )	3,31 ( lb )
Volume test ( dc3 ) - ( in3 )	7,43 ( dc3 )	453,41 ( in3 )
h ( mm ) - ( in )	90,00 ( mm )	3,54 ( in )
L1 ( mm ) - ( in )	250,00 ( mm )	9,84 ( in )
L2 ( mm ) - ( in )	333,00 ( mm )	13,11 ( in )

