

HELM

ZHL760.X

Batteria lavabo incasso a 3 fori. / 3 hole built-in basin mixer.



Batteria lavabo incasso a 3 fori in acciaio inox AISI 316L, con aeratore. Lunghezza bocca 175 mm.

3 hole built-in basin mixer in AISI 316L stainless steel, with aerator. Spout L. 175 mm.

R99500

Parte incasso corpo unico, interasse 200 mm /
Assembled built-in part, interaxe 200 mm.











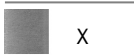



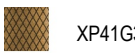
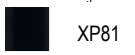

R99504

Parte incasso con elementi liberi, distanza
variabile / Built-in part, not assembled,
variable distance.



Finiture / Finishes

 X Acciaio inox spazzolato / Brushed stainless steel	 XG2 Acciaio inox spazz.-godr. verticale / Br. stainless steel - Vertical knurling	 XG3 Acciaio inox spazz.-godronatura diagonale / Br. stainless steel-diagonal knurling	 XP31 Brushed PVD British gold / -	 XP31G2 Br. PVD British gold-godr. verticale / Br. PVD British gold-vertical knurling	 XP31G3 Br. PVD British gold-godr. diagonale / Br. PVD British gold-diagonal knurling	 XP41 Brushed PVD gold / Brushed PVD gold	 XP41G2 Br. PVD gold-godronatura verticale / Brushed PVD gold-vertical knurling
 XP41G3 Br. PVD gold-godr. diagonale / Br. PVD gold-diagonal knurling	 XP81 PVD Brushed Total Black / PVD Brushed Total Black	 XP81G2 Br. PVD Total Black-godr. verticale / Br. PVD Total Black-vertical knurling	 XP81G3 Br. PVD Total Black-godr. diagonale / Br. PVD Total Black-diagonal knurling	 XP91 Brushed PVD copper / Brushed PVD copper	 XP91G2 Br. PVD copper-godr. verticale / Br. PVD copper-vertical knurling	 XP91G3 Br. PVD copper-godr. diagonale / Br. PVD copper-diagonal knurling	

HELM

ZHL760.X

Disegno Complessivo / Overall Drawing

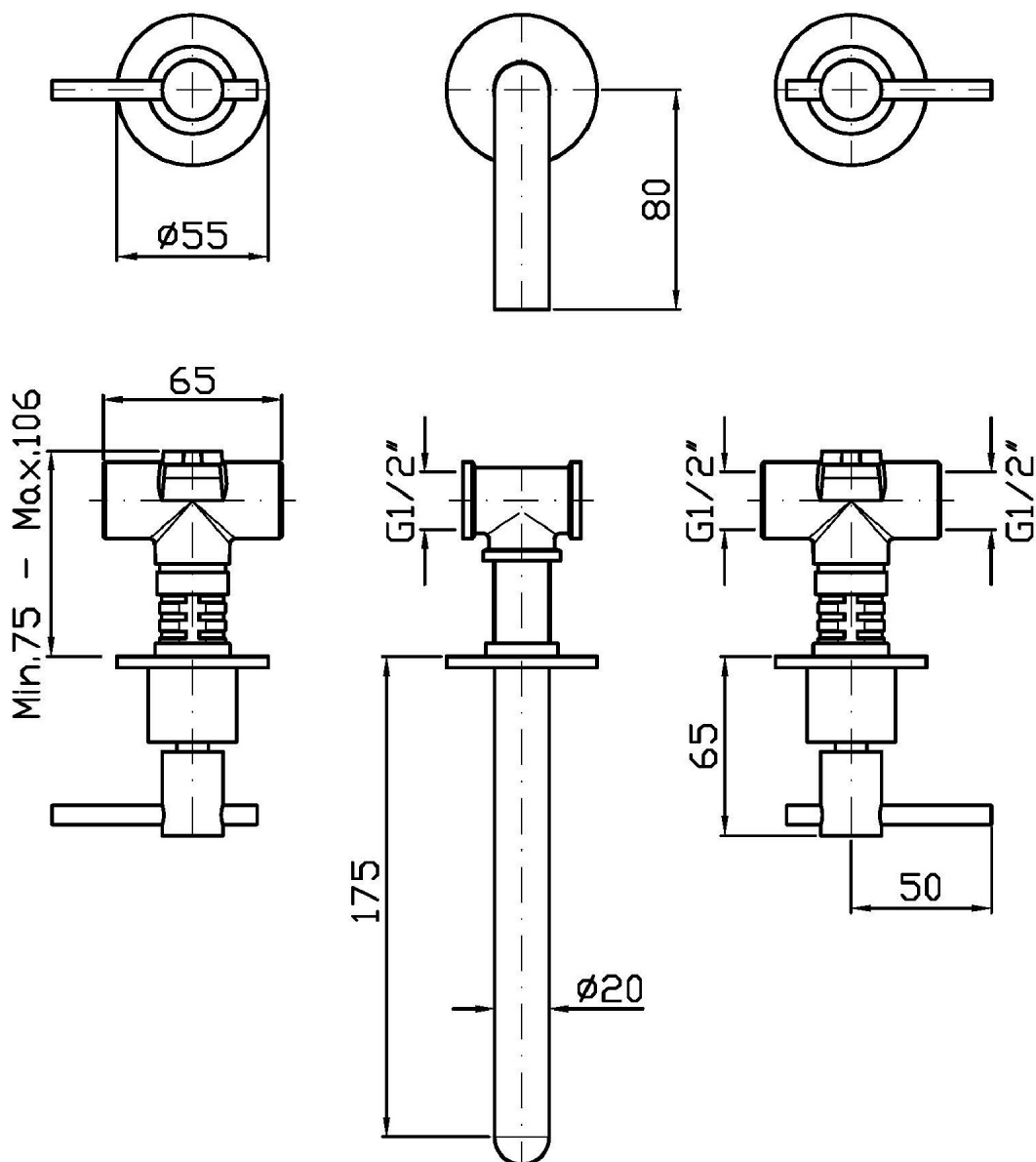

HELM

ZHL760.X Portate / Flowrates (lt/min)

PRESSIONE PRESSURE	1 BAR	2 BAR	3 BAR	4 BAR	5 BAR
P1 LAVABO BASIN	4	4,6	4,8	4,9	5
P2					
P3					
P4					
P5					

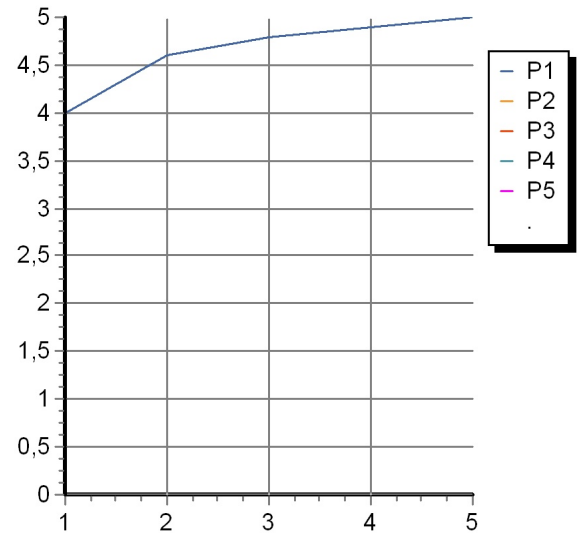

HELM

ZHL760.X Pesì e Misure / Weights and Sizes

Peso (Kg) Weight (lb)	1,80 (Kg)	3,97 (lb)
Volume test (dc3) - (in3)	7,50 (dc3)	457,68 (in3)
h (mm) - (in)	90,00 (mm)	3,54 (in)
L1 (mm) - (in)	250,00 (mm)	9,84 (in)
L2 (mm) - (in)	333,00 (mm)	13,11 (in)

