

Edition 90

59002010103 Single lever basin mixer 250

PRODUCT



DRAWING

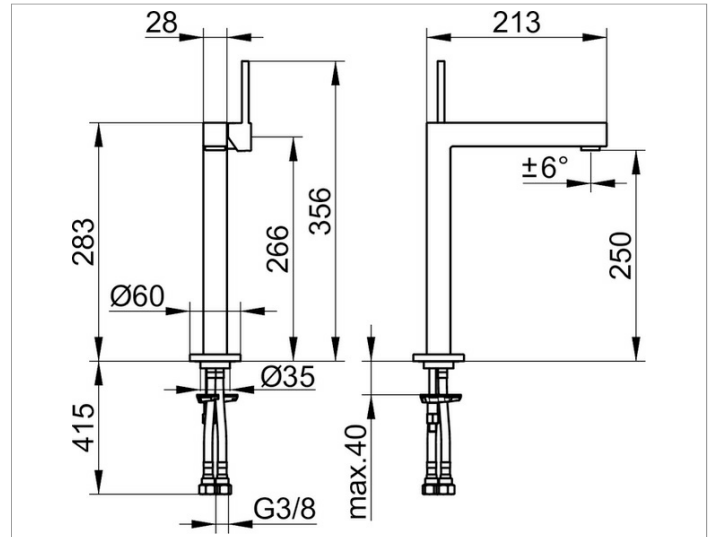

PRODUCT ATTRIBUTES

without pop-up waste,
 single hole installation,
 cartridge with ceramic discs,
 aerator M 24x1, adjustable,
 pressure hoses 435 mm, G 3/8 inch
 flow rate reduced to 7,6 l/min.

SURFACE

chrome-plated