

DE / Gebrauchsanleitung / Montageanleitung	02
FR / Mode d'emploi / Instructions de montage	03
EN / Instructions for use / assembly instructions	04
IT / Istruzioni per l'uso / Istruzioni per Installazione	05
ES / Modo de empleo / Instrucciones de montaje	06
NL / Gebruiksaanwijzing / Handleiding	07
DK / Brugsanvisning / Monteringsvejledning	08
PT / Instruções para uso / Manual de Instalação	09
PL / Instrukcja obsługi / Instrukcja montażu	10
CS / Návod k použití / Montážní návod	11
SK / Návod na použitie / Montážny návod	12
ZH / 用户手册 / 组装说明	13
RU / Руководство пользователя / Инструкция по монтажу	14
HU / Használati útmutató / Szerelési útmutató	15
FI / Käyttöohje / Asennusohje	16
SV / Bruksanvisning / Monteringsanvisning	17
LT / Vartotojo instrukcija / Montavimo instrukcijos	18
HR / Upute za uporabu / Uputstva za instalaciju	19
TR / Kullanım kılavuzu / Montaj kılavuzu	20
RO / Manual de utilizare / Instrucțiuni de montare	21
EL / Οδηγίες χρήσης / Οδηγία συναρμολόγησης	22
SL / Navodilo za uporabo / Navodila za montažo	23
ET / Kasutusjuhend / Paigaldusjuhend	24
LV / Lietošanas pamācība / Montāžas instrukcija	25
SR / Uputstvo za upotrebu / Uputstvo za montažu	26
NO / Bruksanvisning / Montasjeveiledning	27
BG / Инструкция за употреба / Ръководство за монтаж	28
SQ / Udhëzuesi i përdorimit / Udhëzime rreth montimit	29
AR / دليل الاستخدام / تعليمات التجميع	30

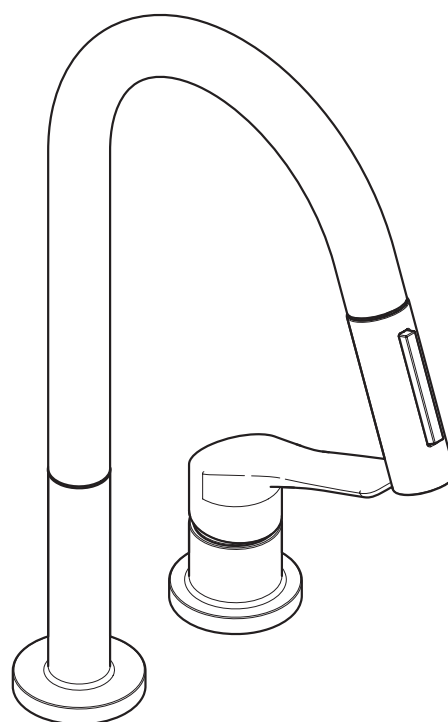

AXOR Citterio M  
34822000 / 34822340 / 34822800  
AXOR Citterio M Eco  
34824000

**⚠ SICHERHEITSHINWEISE**

- ⚠ Bei der Montage müssen zur Vermeidung von Quetsch- und Schnittverletzungen Handschuhe getragen werden.
- ⚠ Große Druckunterschiede zwischen den Kalt- und Warmwasseranschlüssen müssen ausgeglichen werden.

**MONTAGEHINWEISE**

- / Vor der Montage muss das Produkt auf Transportschäden untersucht werden. Nach dem Einbau werden keine Transport- oder Oberflächenschäden anerkannt.
- / Die Leitungen und die Armatur müssen nach den gültigen Normen montiert, gespült und geprüft werden.
- / Die in den Ländern jeweils gültigen Installationsrichtlinien sind einzuhalten.

**TECHNISCHE DATEN**

Betriebsdruck:	max. 1 MPa
Empfohlener Betriebsdruck:	0,1 - 0,5 MPa
Prüfdruck:	1,6 MPa (1 MPa = 10 bar = 147 PSI)
Heißwassertemperatur:	max. 70°C
Empfohlene Heißwassertemperatur:	65°C
Thermische Desinfektion:	max. 70°C / 4 min

Das Produkt ist ausschließlich für Trinkwasser konzipiert!

**SYMBOLERKLÄRUNG**

Kein essigsäurehaltiges Silikon verwenden!



**JUSTIERUNG** (siehe Seite 33)

Einstellen der Warmwasserbegrenzung. In Verbindung mit Durchlauferhitzern ist eine Warmwassersperre nicht zu empfehlen.



**BEDIENUNG** (siehe Seite 34)

Hansgrohe empfiehlt, morgens oder nach längeren Stagnationszeiten den ersten halben Liter nicht als Trinkwasser zu verwenden.



**REINIGUNG** (siehe Seite 38)

Bei vermindertem Wasserdurchsatz Schmutzfangsieb zwischen Faustbrause und Schlauch reinigen.



**WARTUNG** (siehe Seite 38)

Rückflussverhinderer müssen gemäß DIN EN 1717 regelmäßig in Übereinstimmung mit nationalen oder regionalen Bestimmungen auf ihre Funktion geprüft werden (mindestens einmal jährlich).



**MASSE** (siehe Seite 35)



**DURCHFLUSSDIAGRAMM** (siehe Seite 35)

- ① Normalstrahl
- ② Brausestrahl



**SERVICETEILE** (siehe Seite 36)

XXX = Farbcodierung  
000 = Chrom  
340 = Brushed Black Chrome  
800 = Edelstahl-Optik

**SONDERZUBEHÖR** (nicht im Lieferumfang enthalten)



/ Serviceschlüssel #95910000 (siehe Seite 37)



**PRÜFZEICHEN** (siehe Seite 37)

STÖRUNG	URSACHE	ABHILFE
/ Armatur schwergängig	/ Kartusche defekt, verkalkt	/ Kartusche austauschen
/ Armatur tropft	/ Kartusche defekt	/ Kartusche austauschen
/ Wasseraustritt im Bereich des Schwenkauslaufes	/ O-Ring defekt	/ O-Ring austauschen
/ Wasseraustritt am Befestigungsschaft	/ Anschlusschläuche nicht ganz in den Grundkörper eingeschraubt	/ Anschlusschläuche von Hand festziehen
	/ O-Ring am Anschlusschlauch defekt	/ O-Ring austauschen



## ⚠ CONSIGNES DE SÉCURITÉ

- ⚠ Lors du montage, porter des gants de protection pour éviter toute blessure par écrasement ou coupure.
- ⚠ Il est conseillé d'équilibrer les pressions de l'eau chaude et froide.

## INSTRUCTIONS POUR LE MONTAGE











- / Avant son montage, s'assurer que le produit n'a subi aucun dommage pendant le transport. Après le montage, tout dommage de transport ou de surface ne pourra pas être reconnu.
- / Les conduites et la robinetterie doivent être montés, rincés et contrôlés selon les normes en vigueur.
- / Les directives d'installation en vigueur dans le pays concerné doivent être respectées.

## INFORMATIONS TECHNIQUES

Pression de service autorisée:	max. 1 MPa
Pression de service conseillée:	0,1 - 0,5 MPa
Pression maximum de contrôle:	1,6 MPa (1 MPa = 10 bar = 147 PSI)
Température d'eau chaude:	max. 70°C
Température recommandée:	65°C
Désinfection thermique:	max. 70°C / 4 min

Le produit est exclusivement conçu pour de l'eau potable!

## DESCRIPTION DU SYMBOLE

-  Ne pas utiliser de silicone contenant de l'acide acétique!
-  **ETALONNAGE** (voir pages 33)  
Réglage de la limitation d'eau chaude. En liaison avec les chauffe-eau, un blocage de l'eau chaude n'est pas recommandable.
-  **INSTRUCTIONS DE SERVICE** (voir pages 34)  
Hansgrohe recommande de ne pas utiliser le premier demi-litre le matin ou après une période de stagnation prolongée.
-  **NETTOYAGE** (voir pages 38)  
En cas de baisse du débit dévisser la douchette poing et nettoyer le filtre.
-  **ENTRETIEN** (voir pages 38)  
Les clapets anti-retour doivent être examinés régulièrement conformément à la norme EN 1717 ou conformément aux dispositions nationales ou régionales quant à leur fonction (au moins une fois par an).
-  **DIMENSIONS** (voir pages 35)
-  **DIAGRAMME DU DÉBIT** (voir pages 35)  
① Jet de pluie  
② Jet d'eau
-  **PIÈCES DÉTACHÉES** (voir pages 36)  
XXX = Couleurs  
000 = Chromé  
340 = Brushed Black Chrome  
800 = Aspect Acier Inox
- ACCESSOIRES EN OPTION** (ne fait pas partie de la fourniture)  
 / clé #95910000 (voir pages 37)
-  **CLASSIFICATION ACOUSTIQUE ET DÉBIT**  
(voir pages 37)

DYSFONCTIONNEMENT	ORIGINE	SOLUTION
/ Dureté de fonctionnement	/ Cartouche défectueuse, entartrée	/ Changer la cartouche
/ Le mitigeur goutte	/ Cartouche défectueuse	/ Changer la cartouche
/ Fuite à l'embase du bec	/ Joint torique défectueux	/ Changer le joint torique
/ Fuite à la fixation sous le mitigeur	/ Les flexibles de raccordement ne sont pas correctement visser dans le corps.	/ Resserer le flexible à la main.
	/ Joint torique sous les flexible de raccordements défectueux	/ Changer le joint torique



### ⚠ SAFETY NOTES

- ⚠ Gloves should be worn during installation to prevent crushing and cutting injuries.
- ⚠ The hot and cold supplies must be of equal pressures.

### INSTALLATION INSTRUCTIONS

- / Prior to installation, inspect the product for transport damages. After it has been installed, no transport or surface damage will be honoured.
- / The pipes and the fixture must be installed, flushed and tested as per the applicable standards.
- / The plumbing codes applicable in the respective countries must be observed.

### TECHNICAL DATA

Operating pressure:	max. 1 MPa
Recommended operating pressure:	0,1 - 0,5 MPa
Test pressure:	1,6 MPa
	(1 MPa = 10 bar = 147 PSI)
Hot water temperature:	max. 70°C
Recommended hot water temp.:	65°C
Thermal disinfection:	max. 70°C/4 min

The product is exclusively designed for drinking water!

### SYMBOL DESCRIPTION



Do not use silicone containing acetic acid!



ADJUSTMENT (see page 33)

To adjust the hot water limiter. Using a hot water limiter in combination with a continuous flow water heater is not recommended.



OPERATION (see page 34)

Hansgrohe recommends not to use as drinking water the first half liter of water drawn in the morning or after a prolonged period of non-use.



CLEANING (see page 38)

If the waterflow drops, clean the filter located between hose and handspray.



MAINTENANCE (see page 38)

The check valves must be checked regularly according to DIN EN 1717 in accordance with national or regional regulations (at least once a year).



DIMENSIONS (see page 35)



FLOW DIAGRAM (see page 35)

① Normal spray

② Regular



SPARE PARTS (see page 36)

XXX = Colors

000 = Chrome Plated

340 = Brushed Black Chrome

800 = Stainless Steel Optic

SPECIAL ACCESSORIES (order as an extra)



/ service tool #95910000 (see page 37)



TEST CERTIFICATE (see page 37)

FAULT	CAUSE	REMEDY
/ Mixer stiff	/ Cartridge defective, calcified	/ Exchange cartridge
/ Mixer dripping	/ Cartridge defective	/ Exchange cartridge
/ Water escaping in area of swivel spout	/ O-ring defective	/ Exchange O-ring
/ Water escaping at the threaded base	/ connection hoses not completely screwed into basic body	/ Tighten connection hoses by hand
	/ O-ring at the connection hose defective.	/ Exchange O-ring



## ⚠ INDICAZIONI SULLA SICUREZZA

- ⚠ Durante il montaggio, per evitare ferite da schiacciamento e da taglio bisogna indossare guanti protettivi.
- ⚠ Attenzione! Compensare le differenze di pressione tra i collegamenti dell'acqua fredda e dell'acqua calda.

## ISTRUZIONI PER IL MONTAGGIO









- / Prima del montaggio è necessario controllare che non ci siano stati danni durante il trasporto. Una volta eseguito il montaggio, non verranno riconosciuti eventuali danni di trasporto o delle superfici.
- / Montare, lavare e controllare tubature e rubinetteria rispettando le norme correnti.
- / Vanno rispettate le direttive di installazione nazionali vigenti nel rispettivo paese.

## DATI TECNICI

Pressione d'uso:	max. 1 MPa
Pressione d'uso consigliata:	0,1 - 0,5 MPa
Pressione di prova:	1,6 MPa (1 MPa = 10 bar = 147 PSI)
Temperatura dell'acqua calda:	max. 70°C
Temp. dell'acqua calda consigliata:	65°C
Disinfezione termica:	max. 70°C / 4 min

Il prodotto è concepito esclusivamente per acqua potabile!

## DESCRIZIONE SIMBOLO

-  Non utilizzare silicone contenente acido acetico!
-  **TARATURA** (vedi pagg. 33)  
Regolazione del limitatore di erogazione d'acqua calda. Un limitatore di erogazione di acqua calda in combinazione con le caldaie istantanee non è consigliabile.
-  **PROCEDURA** (vedi pagg. 34)  
Hansgrohe raccomanda, di mattina oppure dopo lunghi tempi di stagnazione, di non utilizzare il primo mezzo litro come acqua potabile.
-  **PULITURA** (vedi pagg. 38)  
In caso di diminuzione dell'erogazione pulire il filtro situato tra la doccetta ed il flessibile.
-  **MANUTENZIONE** (vedi pagg. 38)  
La valvola di non ritorno deve essere controllata regolarmente come da DIN EN 1717, secondo le normative nazionali e regionali (almeno una volta all'anno).
-  **INGOMBRI** (vedi pagg. 35)
-  **DIAGRAMMA FLUSSO** (vedi pagg. 35)
  - ① Getto normale a pioggia
  - ② Getto doccia
-  **PARTI DI RICAMBIO** (vedi pagg. 36)
  - XXX = Trattamento
  - 000 = Cromato
  - 340 = Brushed Black Chrome
  - 800 = Acciaio Inox Acciaio
- ACCESSORI SPECIALI** (non contenuto nel volume di fornitura)
  - / chiave per manutenzione #95910000 (vedi pagg. 37)
-  **SEGNO DI VERIFICA** (vedi pagg. 37)

PROBLEMA	POSSIBILE CAUSA	RIMEDIO
/ Miscelatore duro	/ Cartuccia difettosa	/ Sostituire la cartuccia
/ Miscelatore gocciola	/ Cartuccia difettosa	/ Sostituire la cartuccia
/ Perdita di acqua intorno all'erogazione girevole	/ O-ring difettoso	/ Sostituire l'o-ring
/ Perdita di acqua al set di fissaggio	/ I raccordi dei flessibili avvitati male nel corpo incasso	/ Avvitare i raccordi flessibili a mano
	/ O-ring al raccordo flessibile difettoso	/ Sostituire l'o-ring



**INDICACIONES DE SEGURIDAD**

- ⚠ Durante el montaje deben utilizarse guantes para evitar heridas por aplastamiento o corte.
- ⚠ Grandes diferencias de presión en servicio entre agua fría y agua caliente deben equilibrarse.

**INDICACIONES PARA EL MONTAJE**

- / Antes del montaje se debe examinar el producto contra daños de transporte. Después de la instalación no se reconoce ningún daño de transporte o de superficie.
- / Los conductos y la grifería deben montarse, lavarse y comprobarse según las normas vigentes.
- / Es obligatorio el cumplimiento de las directrices de instalación vigentes en el país respectivo.

**DATOS TÉCNICOS**

Presión en servicio:	max. 1 MPa
Presión recomendada en servicio:	0,1 - 0,5 MPa
Presión de prueba:	1,6 MPa (1 MPa = 10 bar = 147 PSI)
Temperatura del agua caliente:	max. 70°C
Temp. recomendada del agua caliente:	65°C
Desinfección térmica:	max. 70°C/4 min

El producto ha sido concebido exclusivamente para agua potable.

**DESCRIPCIÓN DE SÍMBOLOS**

No utilizar silicona que contiene ácido acético!



**AJUSTE** (ver página 33)

Ajuste del límite de agua caliente. En combinación con calentadores continuos no es recomendable utilizar un bloqueo de agua caliente.



**MANEJO** (ver página 34)

Hansgrohe recomienda no utilizar el primer medio litro como agua potable por las mañanas o tras un largo periodo de inactividad.



**LIMPIAR** (ver página 38)

En el caso que se redujera el caudal deberá limpiarse el filtro situado entre la ducha de mano y el tubo.



**MANTENIMIENTO** (ver página 38)

Las válvulas anti-retorno tienen que ser controladas regularmente según la norma DIN EN 1717, en acuerdo con las regulaciones nacionales o regionales (una vez al año, por lo menos).



**DIMENSIONES** (ver página 35)



**DIAGRAMA DE CIRCULACIÓN** (ver página 35)

- ① Chorro de lluvia
- ② Chorro de ducha



**REPUESTOS** (ver página 36)

- XXX = Acabados
- 000 = Cromado
- 340 = Brushed Black Chrome
- 800 = Acero Especial

**OPCIONAL** (no incluido en el suministro)



/ Llave para desmontar #95910000 (ver página 37)



**MARCA DE VERIFICACIÓN** (ver página 37)

PROBLEMA	CAUSA	SOLUCIÓN
/ Manecilla va dura	/ cartucho dañado	/ cambiar el cartucho
/ Grifo pierde agua	/ cartucho dañado	/ cambiar el cartucho
/ Pérdida de agua en el caño giratorio	/ junta dañado	/ cambiar juntas
/ Pérdida de agua en el set de fijación	/ Conexión flexible mal atornillada al cuerpo del caño. / Daños en la junta de la conexión flexible	/ Apretar a mano la conexión flexible / cambiar juntas



## ⚠ VEILIGHEID INSTRUCTIES

- ⚠ Bij de montage moeten ter voorkoming van knel- en snijwonden handschoenen worden gedragen.
- ⚠ Grote drukverschillen tussen de koud- en warmwatertoevoer dienen vermeden te worden.

## MONTAGE-INSTRUCTIES

- / Vóór de montage moet het product gecontroleerd worden op transportschade. Na de inbouw wordt geen transport- of oppervlakteschade meer aanvaard.
- / De leidingen en armaturen moeten gemonteerd, gespoeld en gecontroleerd worden volgens de geldige normen.
- / De in de overeenkomstige landen geldende installatierichtlijnen moeten nageleefd worden.

## TECHNISCHE GEGEVENS

Werkdruk: max.	max. 1 MPa
Aanbevolen werkdruk:	0,1 - 0,5 MPa
Getest bij:	1,6 MPa (1 MPa = 10 bar = 147 PSI)
Temperatuur warm water:	max. 70°C
Aanbevolen warm water temp.:	65°C
Thermische desinfectie:	max. 70°C/4 min

Het product is uitsluitend ontworpen voor drinkwater!

## SYMBOOLBESCHRIJVING

-  Gebruik geen zuurhoudende silicone!
-  **INSTELLEN** (zie blz. 33)  
Instellen van de warmwaterbegrenzing. In combinatie met een doorstromer is een warmwaterblokkering niet aanbevelenswaardig.
-  **BEDIENING** (zie blz. 34)  
Hansgrohe raadt aan om 's morgens na langere stagnatietijden de eerste halve liter niet als drinkwater te gebruiken.
-  **REINIGEN** (zie blz. 38)  
Bij verminderde waterdoorvoer zeefje tussen vuistdouche en slang schoonmaken.
-  **ONDERHOUD** (zie blz. 38)  
Keerleppele moeten volgens DIN EN 1717 regelmatig en volgens plaatselijk geldende eisen op het functioneren gecontroleerd worden. (Tenminste een keer per jaar)
-  **MATEN** (zie blz. 35)
-  **DOORSTROOMDIAGRAM** (zie blz. 35)
  - ① Normale douchestraal
  - ② Douchestraal
-  **SERVICE ONDERDELEN** (zie blz. 36)
  - XXX = Kleuren
  - 000 = Verchromd
  - 340 = Brushed Black Chrome
  - 800 = RVS-look
- TOEBEHOREN** (behoort niet tot het leveringspakket)
  - / Servicesleutel #95910000 (zie blz. 37)
-  **KEURMERK** (zie blz. 37)

STORING	OORZAAK	OPLOSSING
/ Bediening zwaar	/ Kardoes defect of verkalkt	/ Kardoes uitwisselen
/ Mengkraan lekt	/ Kardoes defect	/ Kardoes uitwisselen
/ Lekkage tussen aansluiting uitloop en kraanhuis	/ O-ring defect	/ O-ring uitwisselen
/ Lekkage op montageschacht	/ Aansluitslangen niet geheel in kraanhuis vastgedraaid	/ Aansluitslangen handvast aandraaien
	/ O-ring van aansluitslang defect	/ O-ring uitwisselen



MONTAGE (zie blz. 31)

## ⚠ SIKKERHEDSANVISNINGER

- ⚠ Ved monteringen skal der bruges handsker for at undgå kvæstelser og snitsår.
- ⚠ Større trykforskelle mellem koldt og varmt vand bør udjævnes.

## MONTERINGSANVISNINGER









- / Før monteringen skal produktet kontrolleres for transportskader. Efter monteringen godkendes transportskader eller skader på overfladen ikke længere.
- / Ledningerne og armaturene skal monteres, skylles og kontrolleres iht. de gældende standarder.
- / Installationsbestemmelserne, der gælder i det enkelte land, skal overholdes.

## TEKNISKE DATA

Driftstryk:	max. 1 MPa
Anbefalet driftstryk:	0,1 - 0,5 MPa
Prøvetryk:	1,6 MPa
	(1 MPa = 10 bar = 147 PSI)
Varmtvandstemperatur:	max. 70°C
Anbefalet varmtvandstemperatur:	65°C
Termisk desinfektion:	max. 70°C/4 min

Produktet er udelukkende beregnet til drikkevand!

## SYMBOLBESKRIVELSE

-  Der må ikke benyttes eddikesyreholdig silikone!
-  **FORINDSTILLING** (se s. 33)  
Indstilling af varmvandsbegrænsningen. I forbindelse med gennemstrømningsvandvarmere anbefaler vi ikke en varmvandsspærre.
-  **BRUGSANVISNING** (se s. 34)  
Hansgrohe anbefaler at den første halve liter om morgenen eller efter længere stagneringstider ikke anvendes som drikkevand.
-  **RENGØRING** (se s. 38)  
Ved formindsket vandmængde renses perlatoren.
-  **SERVICE** (se s. 38)  
Ifølge DIN EN 1717 skal gennemstrømningsbegrænsere i overensstemmelse med nationale regler afprøves regelmæssigt (mindst en gang om året).
-  **MÅLENE** (se s. 35)
-  **GENNEMSTRØMNINGSDIAGRAM** (se s. 35)
  - ① Normalstråle
  - ② Brusestråle
-  **RESERVEDELE** (se s. 36)
  - XXX = Overflade
  - 000 = Krom
  - 340 = Brushed Black Chrome
  - 800 = Stainless Steel Optic
- SPECIALTILBEHØR** (ikke med i leveringsomfang)
  - / Monteringsnøgle #95910000 (se s. 37)
-  **GODKENDELSE** (se s. 37)

FEJL	ÅRSAG	HJÆLP
/ Grebet går trægt	/ Kartusche defekt, tilkalket	/ Udskift kartusche
/ Armaturet drypper	/ Defekt kartusche	/ Udskift kartusche
/ Armaturet drypper ved svingtuden.	/ Defekt o-ring	/ Udskift o-ring
/ Armaturet er utæt ved befæstelsesdelene	/ Tilslutningsslangerne er ikke skruet korrekt op i armaturet.	/ Med håndkraft skures tilslutningsslangen strammere på.
	/ Defekt o-ring på tilslutningsslange	/ Udskift o-ring





## ⚠ AVISOS DE SEGURANÇA

- ⚠ Durante a montagem devem ser utilizadas luvas de protecção, de modo a evitar ferimentos resultantes de entalamentos e de cortes.
- ⚠ Grandes diferenças entre as pressões das águas quente e fria devem ser compensadas.

## AVISOS DE MONTAGEM









- / Antes da montagem deve-se controlar o produto relativamente a danos de transporte. Após a montagem não são aceites quaisquer danos de transporte ou de superfície.
- / As tubagens e a torneira têm que ser montadas, enxaguadas e verificadas de acordo com as normas em vigor.
- / A prescrições de instalação válidas nos respetivos países devem ser respeitadas.

## DADOS TÉCNICOS

Pressão de funcionamento:	max. 1 MPa
Pressão de func. recomendada:	0,1 - 0,5 MPa
Pressão testada:	1,6 MPa (1 MPa = 10 bar = 147 PSI)
Temperatura da água quente:	max. 70°C
Temp. água quente recomendada:	65°C
Desinfecção térmica:	max. 70°C / 4 min

Este produto foi única e exclusivamente concebido para água potável!

## DESCRIÇÃO DO SÍMBOLO

-  Não utilizar silicone que contenha ácido acético!
-  **AFINAÇÃO** (ver página 33)  
Ajuste do limitador de água quente. Em combinação com um esquentador, não é recomendável o uso de um bloqueio de água quente.
-  **FUNCIONAMENTO** (ver página 34)  
A Hansgrohe recomenda a não utilização do primeiro meio litro de água, de manhã ou após longas paragens, para fins de consumo.
-  **LIMPEZA** (ver página 38)  
Se notar uma diminuição acentuada do caudal, convém limpar o filtro que está entre o flexível e a cabeça do chuveiro.
-  **MANUTENÇÃO** (ver página 38)  
As válvulas anti-retorno devem ser verificadas regularmente de acordo com a DIN EN 1717 segundo os regulamentos nacionais ou regionais (pelo menos uma vez por ano).
-  **MEDIDAS** (ver página 35)
-  **FLUXOGRAMA** (ver página 35)
  - ① operação normal
  - ② Chuveiro
-  **PEÇAS DE SUBSTITUIÇÃO** (ver página 36)
  - XXX = Acabamentos
  - 000 = Cromado
  - 340 = Brushed Black Chrome
  - 800 = Aço Imaculado Ótica
- ACESSÓRIOS ESPECIAIS** (não incluído no volume de fornecimento)
  - / chave especial #95910000 (ver página 37)
-  **MARCA DE CONTROLO** (ver página 37)

FALHA	CAUSA	SOLUÇÃO
/ Misturadora perra	/ Cartucho defeituoso, calcificado	/ Substituir o cartucho
/ Misturadora a pingar	/ Cartucho defeituoso	/ Substituir o cartucho
/ Perde água na zona da bica rotativa	/ O-ring defeituoso	/ Trocar o-ring
/ Perde água pela base roscada	/ Tubos de ligação não estão completamente enroscados	/ Apertar os tubos de ligação à mão
	/ O-ring dos tubo de ligação defeituoso	/ Trocar o-ring



**Δ WSKAZÓWKI BEZPIECZEŃSTWA**

- Δ Aby uniknąć zranień na skutek zgniecenia lub przecięcia, podczas montażu należy nosić rękawice ochronne.
- Δ Znaczne różnice ciśnień na dopływach ciepłej i zimnej wody muszą zostać wyrównane.

**WSKAZÓWKI MONTAŻOWE**











- / Przed montażem należy skontrolować produkt pod kątem szkód transportowych. Po montażu nie widać żadnych szkód transportowych ani szkód na powierzchni.
- / Przewody i armatura muszą być montowane, płukane i kontrolowane według obowiązujących norm.
- / Należy przestrzegać wytycznych instalacyjnych obowiązujących w danym kraju.

**DANE TECHNICZNE**

Ciśnienie robocze:	maks. 1 MPa
Zalecane ciśnienie robocze:	0,1 - 0,5 MPa
Ciśnienie próbne:	1,6 MPa
	(1 MPa = 10 bary = 147 PSI)
Temperatura wody gorącej:	maks. 70°C
Zalecana temperatura wody gorącej:	65°C
Dezynfekcja termiczna:	maks. 70°C / 4 min

Produkt przeznaczony wyłącznie do wody pitnej!

**OPIS SYMBOLU**

-  Nie stosować silikonów zawierających kwas octowy!
-  **USTAWIANIE** (patrz strona 33)  
Ustawianie ogranicznika ciepłej wody. Używanie ogranicznika temperatury wody w połączeniu z przepływowym podgrzewaczem wody nie jest zalecane.
-  **OBSŁUGA** (patrz strona 34)  
Hansgrohe zaleca, by z rana lub po dłuższym czasie niekorzystania, pierwsze pół litra wody nie używać jako wody pitnej.
-  **CZYSZCZENIE** (patrz strona 38)  
Przy niskim ciśnieniu wody, wyczyścić sitko pomiędzy prysznicem ręcznym a wężem.
-  **KONSERWACJA** (patrz strona 38)  
Zgodnie z normą DIN EN 1717, krajowymi i miejscowymi przepisami, działanie zabezpieczeń przed przepływem zwrotnym musi być kontrolowane (przynajmniej raz w roku).
-  **WYMIARY** (patrz strona 35)
-  **SCHEMAT PRZEPŁYWU** (patrz strona 35)
  - ① Strumień normalny
  - ② Strumień prysznica
-  **CZĘŚCI SERWISOWE** (patrz strona 36)
  - XXX = Kody kolorów
  - 000 = Chrom
  - 340 = Brushed Black Chrome
  - 800 = Stal Szlachetna
- WYPOSAŻENIE SPECJALNE** (Nie jest częścią dostawy)
  -  / Klucza montażowego #95910000 (patrz strona 37)
-  **ZNAK JAKOŚCI** (patrz strona 37)

USTERKA	PRZYCZYNA	POMOC
/ Uchwyt armatury pracuje z wysiłkiem	/ Uszkodzony wkład, zakamieniony	/ Wymiana wkładu
/ Armatura cieknie	/ Uszkodzony wkład	/ Wymiana wkładu
/ Wyciek wody w obszarze wylewki	/ Uszkodzony o-ring	/ Wymienić o-ring
/ Wyciek wody przy mocowaniu od dołu	/ Zbyt słabo wkręcone wężyki w korpus	/ Dokręcić wężyki
	/ Uszkodzony o-ring przy wężu przyłączeniowym	/ Wymienić o-ring



## ⚠ BEZPEČNOSTNÍ POKYNY

- ⚠ Pro zabránění řezným zraněním a pohmožděninám je nutné při montáži nosit rukavice.
- ⚠ Je nutné vyrovnat velké rozdíly tlaku mezi přípoji studené a teplé vody.

## POKYNY K MONTÁŽI









- / Před montáží je třeba produkt zkontrolovat, zda nebyl při transportu poškozen. Po zabudování nebudou uznány žádné škody způsobené transportem nebo poškození povrchu.
- / Vedení a armatura musí být namontovány, propláchnuty a otestovány podle platných norem.
- / Je třeba dodržovat montážní pravidla platné v dané zemi.

## TECHNICKÉ ÚDAJE

Provozní tlak:	max. 1 MPa
Doporučený provozní tlak:	0,1 - 0,5 MPa
Zkušební tlak:	1,6 MPa (1 MPa = 10 bar = 147 PSI)
Teplota horké vody:	max. 70°C
Doporučená teplota horké vody:	65°C
Teplná desinfekce:	max. 70°C / 4 min

Výrobky Hansgrohe jsou vhodné pro přímý kontakt s pitnou vodou.

## POPIS SYMBOLŮ

-  Nepoužívat silikon s obsahem kyseliny octové!
-  **NASTAVENÍ** (viz strana 33)  
Nastavení omezovače teplé vody. Ve spojení s průtokovým ohřívačem se použití uzávěru teplé vody nedoporučuje.
-  **OVLÁDÁNÍ** (viz strana 34)  
Hansgrohe doporučuje ráno nebo po delších přestávkách nepoužívat prvního půl litru jako pitnou vodu.
-  **ČIŠTĚNÍ** (viz strana 38)  
Při sníženém průtoku vyčistit sítko zachycující nečistoty mezi sprchou a hadicí.
-  **ÚDRŽBA** (viz strana 38)  
U zpětných ventilů se musí podle DIN EN 1717 v souladu s národními nebo regionálními předpisy testovat jejich funkčnost (alespoň jednou ročně).
-  **ROZMĚRY** (viz strana 35)
-  **DIAGRAM PRŮTOKU** (viz strana 35)
  - ① Normální proud
  - ② Ruční sprcha
-  **SERVISNÍ DÍLY** (viz strana 36)
  - XXX = Kód povrchové úpravy
  - 000 = Chrom
  - 340 = Brushed Black Chrome
  - 800 = Nerezová Ocel
- ZVLÁŠTNÍ PŘÍSLUŠENSTVÍ** (není součástí dodávky)
  - / Servisní klíč #95910000 (viz strana 37)
-  **ZKUŠEBNÍ ZNAČKA** (viz strana 37)

PORUCHA	PŘÍČINA	ODSTRANĚNÍ
/ Armatura jde ztěžka	/ Kartuše je vadná, zanesená vodním kamenem	/ Kartuši vyměnit
/ Armatura odkapává	/ Kartuše je vadná	/ Kartuši vyměnit
/ výstup vody v rozsahu otočného výtoku	/ O-kroužek je defektní	/ vyměnit O-kroužek
/ výstup vody na upevňovacím násadci	/ přípojovací hadice nejsou dostatečně zašroubovány do tělesa	/ přípojovací hadice utáhnout rukou
	/ O-kroužek na přípojovací hadici je defektní	/ vyměnit O-kroužek



**⚠ BEZPEČNOSTNÉ POKYNY**

- ⚠ Pri montáži musíte nosiť rukavice, aby ste predišli pomliaždeninám a rezným poraneniam.
- ⚠ Veľké rozdiely v tlaku medzi prípojkami studenej a teplej vody musia byť vyrovnané.

**POKYNY PRE MONTÁŽ**











- / Pred montážou musíte produkt skontrolovať, či nebol počas transportu poškodený. Po zabudovaní nebudú uznané žiadne škody spôsobené transportom alebo poškodenia povrchu.
- / Ledningarna och blandaren måste monteras, spolás igenom och kontrolleras enligt de gällande normerna.
- / Je potrebné dodržiavať smernice o inštalácii, ktoré sú práve teraz platné v krajinách.

**TECHNICKÉ ÚDAJE**

Prevádzkový tlak:	max. 1 MPa
Doporučený prevádzkový tlak:	0,1 - 0,5 MPa
Skúšobný tlak:	1,6 MPa (1 MPa = 10 bar = 147 PSI)
Teplota teplej vody:	max. 70°C
Doporučená teplota teplej vody:	65°C
Termická dezinfekcia:	max. 70°C/4 min

Výrobok je koncipovaný výhradne pre pitnú vodu!

**POPIS SYMBOLOV**

-  Nepoužívať silikón s obsahom kyseliny octovej!
-  **NASTAVENIE** (viď strana 33)  
Nastavenie obmedzenia teplej vody. V spojení s prietokovými ohrievačmi sa neodporúča použitie obmedzovača teplej vody.
-  **OBSLUHA** (viď strana 34)  
Hansgrohe odporúča ráno a po dlhších dobách odstavky nepoužiť prvého pol litra vody ako pitnú vodu.
-  **ČISTENIE** (viď strana 38)  
Pri poklese prietoku vody vyčistiť filter umiestnený medzi hadicou a sifónom.
-  **ÚDRŽBA** (viď strana 38)  
Pri spätných ventiloch sa musí podľa DIN EN 1717 v súlade s národnými alebo regionálnymi predpismi testovať ich funkčnosť (aspoň raz ročne).
-  **ROZMERY** (viď strana 35)
-  **DIAGRAM PRIETOKU** (viď strana 35)
  - ① Normálny prúd
  - ② Sprchový prúd
-  **SERVISNÉ DIELY** (viď strana 36)
  - XXX = Farebné označenie
  - 000 = Chróm
  - 340 = Brushed Black Chrome
  - 800 = Ušľachtilá Oceľ
- ZVLÁŠTNE PRÍSLUŠENSTVO** (nie je súčasťou dodávky)
  - /  Servisný kľúč #95910000 (viď strana 37)
  - /  **OSVEDČENIE O SKÚŠKE** (viď strana 37)

PORUCHA	PRÍČINA	POMOC
/ Armatúra "chodí" ľahko	/ Kartúša je poškodená, vápenaté usadeniny	/ Vymeniť kartušu
/ Z armatúry kvapká voda	/ Kartúša je poškodená	/ Vymeniť kartušu
/ Uhajanie vode ob vrtľivem izlivu	/ Chybný O krúžok	/ Vymeniť O krúžok
/ Uhajanje vode ob pritrdilnem nastavku	/ Hadice pripojenia nie sú celkom zaskrutkované do základného telesa	/ Hadice pripojenia dotiahnuť ručne
	/ Chybný O krúžok na pripojovacej hadici	/ Vymeniť O krúžok



### △ 安全技巧

- △ 装配时为避免挤压和切割受伤，必须戴上手套。
- △ 冷热水管间过大的压力差必须予以平衡。

### 安装提示

- / 安装前必须检查产品是否受到运输损害。安装后将不认可运输损害或表面损伤。
- / 管道和阀门必须根据通用标准进行安装、冲洗和检查。
- / 请遵守当地国家现行的安装规定。

### 技术参数

工作压强:	最大 1 MPa
推荐工作压强:	0,1 - 0,5 MPa
测试压强:	1,6 MPa
	(1 MPa = 10 bar = 147 PSI)
热水温度:	最大 70°C
推荐热水温度:	65°C
热力消毒:	最大 70°C / 4 分钟

该产品专为饮用水设计！

### 符号说明

-  请勿使用含有乙酸的硅胶！
-  调节 (参见第页 33)  
热水温度调节。如果使用即热式喷头，则不建议安装热水阀门。
-  操作 (参见第页 34)  
汉斯格雅建议，清晨或在水流长时间停滞，前半升水不作饮用水使用。
-  清洗 (参见第页 38)  
如果水流减少，清洁位于花洒头和软管之间的过滤网。
-  保养 (参见第页 38)  
单向阀必须在符合国家或当地的法律的情况下按照DIN EN 1717定期检查（至少一年一次）。
-  大小 (参见第页 35)
-  流量示意图 (参见第页 35)
  - ① 普通水流
  - ② 花洒
-  备用零件 (参见第页 36)
  - XXX = 颜色代码
  - 000 = 镀铬
  - 340 = Brushed Black Chrome
  - 800 = 不锈钢表面
- 选装附件 (不在供货范围内)
  - / 操作扳手 #95910000 (参见第页 37)
-  检验标记 (参见第页 37)

问题	原因	补救
/ 龙头不灵活	/ 阀芯损坏、结垢	/ 更换阀芯
/ 龙头滴水	/ 阀芯损坏	/ 更换阀芯
/ 水从龙头出水嘴流出	/ O形环损坏	/ 更换O形环
/ 水从螺纹底座中流出	/ 连接软管没有完全旋入基体	/ 用手拧紧连接软管
	/ 连接软管的O形环损坏	/ 更换O形环

## ⚠ УКАЗАНИЯ ПО ТЕХНИКЕ БЕЗОПАСНОСТИ

- ⚠ Во время монтажа следует надеть перчатки во избежание прищемления и порезов.
- ⚠ донного клапа. Перед установкой смесителя необходимо регулировочными кранами выровнять давление холодной и горячей воды при помощи вентилей регулирующих подачу воды в квартиру.

## УКАЗАНИЯ ПО МОНТАЖУ

- / Перед монтажом следует проверить изделие на предмет повреждений при перевозке. После монтажа претензии о возмещении ущерба за повреждения при перевозке или повреждения поверхностей не принимаются.
- / Трубы и арматура должны быть установлены, промыты и проверены в соответствии с действующими нормами.
- / Необходимо соблюдать требования по монтажу, действующие в соответствующих странах.

## ТЕХНИЧЕСКИЕ ДАННЫЕ

Рабочее давление:	не более. 1 МПа
Рекомендуемое рабочее давление:	0,1 - 0,5 МПа
Давление:	1,6 МПа
	(1 МПа = 10 bar = 147 PSI)
Температура горячей воды:	не более. 70°C
Рекомендуемая темп. гор. воды:	65°C
Термическая дезинфекция:	не более. 70°C/4 мин

Изделие предназначено исключительно для питьевой воды!

## ОПИСАНИЕ СИМВОЛОВ



Не применяйте силикон, содержащий уксусную кислоту.



**ПОДГОНКА** (см. стр. 33)

Регулировка ограничителя горячей воды. В сочетании с проточными нагревателями не рекомендуется использовать блокировку воды.



**ЭКСПЛУАТАЦИЯ** (см. стр. 34)

Hansgrohe рекомендует по утрам либо после длительного перерыва в использовании не использовать первые поллитра воды для питья.



**ОЧИСТКА** (см. стр. 38)

При сокращенном расходе воды очистите грязеуловитель между ручным душем и шлангом.



**ТЕХНИЧЕСКОЕ ОБСЛУЖИВАНИЕ** (см. стр. 38)

Защита обратного тока должна регулярно проверяться (минимум один раз в год) по стандарту DIN EN 1717 или в соответствии с национальными или региональными нормативами



**РАЗМЕРЫ** (см. стр. 35)



**СХЕМА ПОТОКА** (см. стр. 35)

① Нормальная струя

② Струя душа



**КОМПЛЕКТ** (см. стр. 36)

XXX = Цветная кодировка

000 = Хром

340 = Brushed Black Chrome

800 = Сталь

## СПЕЦИАЛЬНЫЕ ПРИНАДЛЕЖНОСТИ

(не включено в объем поставки!)



/ Сервисный ключ #95910000 (см. стр. 37)



**ЗНАК ТЕХНИЧЕСКОГО КОНТРОЛЯ** (см. стр. 37)

НЕИСПРАВНОСТЬ	ПРИЧИНА	УСТРАНЕНИЕ НЕИСПРАВНОСТИ
/ Арматура работает с усилием	/ Картридж неисправен, засорение накипью	/ Замените картридж
/ Арматура протекает	/ Картридж неисправен	/ Замените картридж
/ Выход воды в области поворотного выхода	/ Уплотнительное кольцо круглого сечения неисправно	/ Замените уплотнительное кольцо круглого сечения
/ Выход воды у основания крепления	/ Шланги подключения не полностью завернуты в корпус	/ Затяните шланги подключения вручную
	/ Уплотнительное кольцо круглого сечения на соединительном шланге неисправно	/ Замените уплотнительное кольцо круглого сечения



## ⚠ BIZTONSÁGI UTASÍTÁSOK

- ⚠ A szerelésnél a zúzódások és vágási sérülések elkerülése érdekében kesztyűt kell viselni.
- ⚠ A hidegvíz- és a melegvíz-csatlakozások közötti nagy nyomáskülönbséget kikell egyenlíteni!

## SZERELÉSI UTASÍTÁSOK











- / A szerelés előtt ellenőrizni kell, hogy a terméknek nincs-e szállítási sérülése. Beépítés után a szállítási- vagy felületi sérüléseket nem ismerik el.
- / A vezetékeket és a csaptelepet az érvényes szabványoknak megfelelően kell felszerelni, öblíteni és ellenőrizni
- / Az egyes országokban érvényes installációs irányelveket be kell tartani.

## MŰSZAKI ADATOK

Üzemi nyomás:	max. 1 MPa
Ajánlott üzemi nyomás:	0,1 - 0,5 MPa
Nyomáspróba:	1,6 MPa
	(1 MPa = 10 bar = 147 PSI)
Forróvíz hőmérséklet:	max. 70°C
Forróvíz javasolt hőmérséklete:	65°C
Termikus fertőtlenítés:	max. 70°C/4 perc

A terméket kizárólag ivóvízhez tervezték!

## SZIMBÓLUMOK LEÍRÁSA

-  Ne használjon ecetsavtartalmú szilikonl!
-  **BEÁLLÍTÁS** (lásd a oldalon 33)  
A meleg víz korlátozás beállítása. Átfolyós vízmelegítőknél meleg víz korlátozó használata nem ajánlott.
-  **HASZNÁLAT** (lásd a oldalon 34)  
A Hansgrohe azt ajánlja, hogy hosszabb állási idő után az első fél liter vizet ne használja ivóvízként.
-  **TISZTÍTÁS** (lásd a oldalon 38)  
Csökkent vízáteresztés esetén tisztítsa meg a kézi zuhany és a tömlő közti szennyfogó szűrőt.
-  **KARBANTARTÁS** (lásd a oldalon 38)  
A visszafolyásgátlók működése a DIN EN 1717 szabványnak megfelelően, a nemzeti vagy területi rendelkezésekkel összhangban, évente egyszer ellenőrizendő!
-  **MÉRETET** (lásd a oldalon 35)
-  **ÁTFOLYÁSI DIAGRAMM** (lásd a oldalon 35)  
① Normálsugár  
② Zuhanyugár
-  **TARTOZÉKOK** (lásd a oldalon 36)  
XXX = Színkódolás  
000 = Króm  
340 = Brushed Black Chrome  
800 = Acéloptika
- EGYÉB TARTOZÉK** (a szállítási egység nem tartalmazza)  
 / Szervíz kulcs #95910000 (lásd a oldalon 37)
-  **VIZSGAJEL** (lásd a oldalon 37)

HIBA	OK	MEGOLDÁS
/ Nehezen nyitható a csap.	/ A kerámiabetét meghibásodott, elvízkövesedett.	/ A kerámiabetétet ki kell cserélni.
/ Csöpög a csap.	/ A kerámiabetét meghibásodott.	/ A kerámiabetétet ki kell cserélni.
/ Vízkilépés a billenthető kifolyó területén	/ Tömítógyűrű meghibásodott	/ Tömítógyűrű kicserélése
/ Vízkilépés a rögzítőórúdon	/ A csatlakozótömlők nincsenek teljesen becsavarozva az akaptesbe	/ A csatlakozótömlőket kézzel meghúzni
	/ Csatlakozótömlő tömítógyűrűje meghibásodott	/ Tömítógyűrű kicserélése



**△ TURVALLISUUSOHJEET**

- △ Asennuksessa on käytettävä käsiineitä puristumien ja viiltojen aiheuttamien tapaturmien estämiseksi.
- △ Suuret paine-erot kylmä- ja kuumavesiliitäntöjen välillä on tasattava.

**A SENNUSOHJEET**

- / Ennen asennusta on tarkastettava tuotteen mahdolliset kuljetusvahingot. Asennuksen jälkeen kuljetus- ja pintavaurioita ei hyväksytä.
- / Putket ja hana on asennettava, huuhdeltava ja tarkastettava voimassa olevien standardien mukaisesti.
- / Jokaisessa maassa on noudatettava siellä päteviä asennusohjeita.

**TEKNISET TIEDOT**

Käyttöpain:	maks. 1 MPa
Suosittelun käyttöpain:	0,1 - 0,5 MPa
Koestuspaine:	1,6 MPa
	(1 MPa = 10 bar = 147 PSI)
Kuuman veden lämpötila:	maks. 70°C
Kuuman veden suosituslämpötila:	65°C
Lämpödesinfektio:	maks. 70°C/4 min

Tuote on suunniteltu käytettäväksi ainoastaan juomaveden kanssa!

**MERKIN KUVAUS**

-  Älä käytä etikkahappopitoista silikonia!
-  **S Ä Ä T Ö** (katso sivu 33)  
Lämpötilan rajoittimen säätäminen. Emme suosittele käyttämään lämpötilan rajoittinta vedenlämmittimen (läpivirtauskuumennin) yhteydessä.
-  **K Ä Y T T Ö** (katso sivu 34)  
Hansgrohe suosittelee, että ensimmäistä puolta litraa ei käytetä juomavetenä aamuisin eikä silloin, kun laitetta ei ole käytetty pitkään aikaan.
-  **P U H D I S T U S** (katso sivu 38)  
Jos veden virtausmäärä pienenee, puhdista käsisuihkun ja letkun välissä oleva likasihti.
-  **H U O L T O** (katso sivu 38)  
Vastaventtiilien toiminta on tarkastettava säännöllisesti paikallisten ja kansallisten määräysten mukaisesti (DIN EN 1717, vähintään kerran vuodessa).
-  **M I T A T** (katso sivu 35)
-  **V I R T A U S D I A G R A M M I** (katso sivu 35)
  - ① Normaalisuihku
  - ② Suihku
-  **V A R A O S A T** (katso sivu 36)
  - XXX = Värikoodaus
  - 000 = Kromi
  - 340 = Brushed Black Chrome
  - 800 = Inox-Optinen
- E R I T Y I S V A R U S T E** (ei kuulu toimitukseen)
  - / Service-avain #95910000 (katso sivu 37)
-  **K O E S T U S M E R K K I** (katso sivu 37)

HÄIRIÖ	SYY	TOIMENPIDE
/ Hana on raskaskäyttöinen	/ Patruuna rikki, kalkkikerrostumia	/ Vaihda patruuna
/ Hanasta tippuu vettä	/ Patruuna rikki	/ Vaihda patruuna
/ Vettä valuu kääntyvän juoksuputken juuresta	/ O-rennas on rikki	/ Vaihda O-rennas
/ Vettä valuu kiinnityskauluksesta	/ Liitosletkut eivät ole kierretty kiinni perusrunkoon pohjaan asti	/ Kierrä liitosletkut kiinni käsikireyteen
	/ Liitosletkun O-rennas on rikki	/ Vaihda O-rennas





## ⚠ SÄKERHETSANVISNINGAR

- ⚠ Handskar ska bäras under monteringsarbetet så att man kan undvika kläm- och skärskadorna.
- ⚠ Stora tryckskillnader mellan anslutningarna för varmt och kallt vatten måste utjämnas.

## MONTERINGSANVISNINGAR









- / Det måste undersökas om produkten har transportskador innan den monteras. Efter monteringen accepteras inga transport- eller ytskiktsskador.
- / Ledningarna och blandaren måste monteras, spolats igenom och kontrolleras enligt de gällande normerna.
- / De installationsriktlinjer som gäller i länderna ska följas.

## TEKNISKA DATA

Driftstryck:	max. 1 MPa
Rek. driftstryck:	0,1 - 0,5 MPa
Tryck vid provtryckning:	1,6 MPa (1 MPa = 10 bar = 147 PSI)
Varmvattentemperatur:	max. 70°C
Rek. varmvattentemp.:	65°C
Termisk desinfektion:	max. 70°C / 4 min

Produkten är enbart avsedd för dricksvatten!

## SYMBOLFÖRKLARING

-  Använd inte silikon som innehåller ättiksyra!
-  **JUSTERING** (se sidan 33)  
Ställa in varmvattenregleringen. Tillsammans med varmvattenberedare rekommenderas inte en varmvattenspär.
-  **HANTERING** (se sidan 34)  
Hansgrohe rekommenderar att den första halvlitern inte används som dricksvatten på morgonen eller efter längre perioder utan användning.
-  **RENGÖRING** (se sidan 38)  
Om vattenflödet minskar behöver smutsfiltret mellan handduschen och slangen göras ren.
-  **SKÖTSEL** (se sidan 38)  
Backventilens funktion måste kontrolleras regelbundet enligt nationella eller regionala bestämmelser i enlighet med DIN EN 1717 (minst en gång per år).
-  **MÅTTEN** (se sidan 35)
-  **FLÖDESSCHEMA** (se sidan 35)
  - ① Normalstråle
  - ② Duschstråle
-  **RESERVDELAR** (se sidan 36)
  - XXX = Färgkodning
  - 000 = Krom
  - 340 = Brushed Black Chrome
  - 800 = Rostfri-Optik
- SPECIALTILLBEHÖR** (medföljer ej leveransen)
  - / Servicenöckel #95910000 (se sidan 37)
-  **TESTSIGILL** (se sidan 37)

STÖRNING	ORSAK	ÅTGÄRD
/ Blandare är trög	/ Patron defekt, förkalkad	/ Byt ut patron
/ Blandare droppar	/ Patron defekt	/ Byt ut patron
/ Vatten kommer ut vid den svängbara blandaren	/ O-ring defekt	/ Byt ut O-ring
/ Vatten kommer ut vid monteringsstaget	/ Anslutningsslangar inte helt inskrivade i grundkonstruktionen	/ Drag fast anslutningsslangar för hand.
	/ O-ring på anslutningsslang defekt	/ Byt ut O-ring



## SAUGUMO TECHNIKOS NURODYMAI

- ⚠ Apsaugai nuo užspaudimo ir įsijovimo montavimo metu mūvėkite pirštines.
- ⚠ Turi būti išlyginti šalto ir karšto slėgio nelygumai.

## MONTAVIMO INSTRUKCIJA

- / Prieš montuojant būtina patikrinti, ar gaminys nebuvo pažeistas transportavimo metu. Sumontavus pretenzijos dėl transportavimo ir paviršiaus pažeidimų nepriimamos.
- / Vamzdžiai ir sujungimai turi būti montuojami, plaunami ir tikrinami pagal galiojančias normas.
- / Laikytės atitinkamoje šalyje galiojančių direktyvų dėl įrengimo.

## TECHNINIAI DUOMENYS

Darbinis slėgis:	ne daugiau kaip 1 MPa
Rekomenduojamas slėgis:	0,1 - 0,5 MPa
Bandomasis slėgis:	1,6 MPa (1 MPa = 10 barų = 147 PSI)
Karšto vandens temperatūra:	ne daugiau kaip 70°C
Rekomenduojama karšto vandens temperatūra:	65°C
Terminis dezinfekavimas:	ne daugiau kaip 70°C/4 min

Produktas skirtas tik geriamajam vandeniui!

## SIMBOLIO APRAŠYMAS



Nenaudokite silikono, kurio sudėtyje yra acto rūgšties!



**REGULIAVIMAS** (žr. psl. 33)

Karšto vandens ribojimas. Kartu su cirkuliaciniais šildytuvais nerekomenduojama naudoti karšto vandens blokavimo įtaisų.



**EKSPLOATACIJA** (žr. psl. 34)

Naudojant po ilgesnės pertraukos, „Hansgrohe“ rekomenduoja pirmo pusės litro vandens nevertoti kaip geriamojo.



**VALYMAS** (žr. psl. 38)

Jei sumažėja vandens slėgis, išvalykite filtrą, esantį tarp žarnos ir dušelio rankoms.



**TECHNINIS APTARNAVIMAS** (žr. psl. 38)

Atbulinio vožtuvo apsauga privalo būti tikrinama reguliariai (mažiausiai kartą per metus) pagal DIN EN1717 arba pagal galiojančias nacionalines arba regionines normas.



**IŠMATAVIMAI** (žr. psl. 35)



**PRALAUDUMO DIAGRAMA** (žr. psl. 35)

- ① Normali srovė
- ② Dušo srovė



**ATSARGINĖS DALYS** (žr. psl. 36)

XXX = Spalvos  
000 = Chrom  
340 = Brushed Black Chrome  
800 = Plienas

**SPECIALŪS PRIEDAI** (nėra pridedama)



/ Techninės priežiūros raktas #95910000 (žr. psl. 37)



**BANDYMO PAŽYMA** (žr. psl. 37)

## GEDIMAS

- / Sunkiai sukiojama rankenėlė
- / Maišytuvą praleidžia vandenį
- / Prateka vanduo po čiaupu
- / Prateka vanduo per tvirtinimo kotą

## PRIEŽASTIS

- / Kasetė pažeista, užkalkėjusi
- / Kasetė pažeista
- / tarpinė pažeista
- / Prijungimo žarnos nepilnai įsuktos į korpusą
- / Pajungimo žarnos tarpinė pažeista

## PRIEMONĖ

- / Pakeisti kasetę
- / Pakeisti kasetę
- / tarpinę pakeisti
- / Prijungimo žarnas prisukti ranka
- / tarpinę pakeisti



## ⚠ SIGURNOSNE UPUTE

- ⚠ Prilikom montaže se radi sprječavanja prignječenja i posjekotina moraju nositi rukavice.
- ⚠ Velika razlika u pritisku između vruće i hladne vode mora biti izbalansirana.

## UPUTE ZA MONTAŽU











- / Prije montaže mora se provjeriti je li proizvod oštećen prilikom transporta. Nakon ugradnje se ne priznaju nikakve reklamacije koje se odnose na površinska i transportna oštećenja.
- / Cijevi i armatura moraju biti postavljeni, isprani i testirani prema važećim normama.
- / Obvezno se moraju uvažiti propisi o instalacijama koji vrijede u dotičnoj zemlji.

## TEHNIČKI PODATCI

Najveći dopušteni tlak:	tlak 1 MPa
Preporučeni tlak:	0,1 - 0,5 MPa
Probni tlak:	1,6 MPa
	(1 MPa = 10 bar = 147 PSI)
Temperatura vruće vode:	tlak 70°C
Preporučena temperatura vruće vode:	65°C
Termička dezinfekcija:	tlak 70°C/4 min

Proizvod je koncipiran isključivo za pitku vodu!

## OPIS SIMBOLA

-  Nemojte koristiti silikon koji sadrži octenu kiselinu!
-  **REGULACIJA** (pogledaj stranicu 33)  
Namještanje limitera tople vode. U kombinaciji s protočnim bojlerima nije preporučljiva primjena sustava za blokiranje dotoka tople vode.
-  **UPOTREBA** (pogledaj stranicu 34)  
Hansgrohe preporuča da ujutro ili nakon duljeg nekorisćenja prvih 1/2 litre vode ne upotrebljavate za piće.
-  **ČIŠĆENJE** (pogledaj stranicu 38)  
Ukoliko ne izlazi dovoljno vode, moguće je da se na filteru između tuša i cijevi nakupila prljavština. Očistite filter.
-  **ODRŽAVANJE** (pogledaj stranicu 38)  
Ispravnost nepovratnog ventila mora se redovito provjeravati prema standardu DIN EN 1717 i u skladu sa važećim propisima (najmanje jednom godišnje).
-  **MJERE** (pogledaj stranicu 35)
-  **DIJAGRAM PROTOKA** (pogledaj stranicu 35)
  - ① Normalni mlaz
  - ② mlaz
-  **REZERVNI DJELOVI** (pogledaj stranicu 36)
  - XXX = Boje
  - 000 = Krom
  - 340 = Brushed Black Chrome
  - 800 = Plemeniti Čelik
- POSEBNI PRIBOR** (Nije sadržano u isporuci!)
  -  / Servisni odvijač #95910000 (pogledaj stranicu 37)
  -  **OZNAKA TESTIRANJA** (pogledaj stranicu 37)

GREŠKA	UZROK	OTKLANJANJE
/ Ručica se zaglavila	/ Neispravan uložak Taloženje kamenca	/ Zamijenite uložak
/ Slavina kaplje	/ Neispravan uložak	/ Zamijenite uložak
/ Voda izlazi u području rotirajućih dijelova slavine	/ O-prsten je neispravan	/ Zamijenite O-prsten
/ Voda izlazi na dijelu gdje je slavina učvršćena	/ Priključna crijeva nisu potpuno učvršćena na tijelo	/ Priključna crijeva učvrstite rukom
	/ O-prsteni priključnih crijeva su neispravni	/ Zamijenite O-prsten



SASTAVLJANJE (pogledaj stranicu 31)

**⚠ GÜVENLİK UYARILARI**

- ⚠ Montaj esnasında ezilme ve kesilme gibi yaralanmaları önlemek için eldiven kullanılmalıdır.
- ⚠ Sıcak ve soğuk su bağlantıları arasında büyük basınç farklılıkları varsa, bu basınç farklılıklarının dengelenmesi gerekir.

**MONTAJ AÇIKLAMALARI**









- / Montaj işleminden önce ürün nakliye hasarları yönünden kontrol edilmelidir. Montaj işleminden sonra nakliye veya yüzey hasarları için sorumluluk üstlenilmemektedir.
- / Boruların ve armatürün montajı, yıkanması ve kontrolü geçerli normlara göre yapılmalıdır.
- / Ülkelerde geçerli kurulum yönetmeliklerine riayet edilmelidir.

**TEKNİK BİLGİLER**

İşletme basıncı:	azami 1 MPa
Tavsiye edilen işletme basıncı:	0,1 - 0,5 MPa
Kontrol basıncı:	1,6 MPa (1 MPa = 10 bar = 147 PSI)
Sıcak su sıcaklığı:	azami 70°C
Tavsiye edilen su ısısı:	65°C
Termik dezenfeksiyon:	azami 70°C/4 dak

Ürün sadece şebeke suyu için tasarlanmıştır!

**SİMGE AÇIKLAMASI**

-  Asetik asit içeren silikon kullanmayın!
-  **AYARLAMA** (bakınız sayfa 33)  
Sıcak su sınırlamasının ayarlanması. Sıcak su kilitinin sürekli ısıtıcıyla kullanılması tavsiye edilmez.
-  **KULLANIMI** (bakınız sayfa 34)  
Hansgrohe sabahları uzun durgunluk süresi sonrasında ilk yarım litre suyun içme suyu olarak kullanılmamasını önerir.
-  **TEMİZLEME** (bakınız sayfa 38)  
Su debisinin azalması durumunda, el duşu ve hortum arasındaki filtreyi temizleyin.
-  **BAKIM** (bakınız sayfa 38)  
DIN EN 1717 ve ulusal standartlar doğrultusunda Çek valfler düzenli olarak kontrol edilmelidir. ( en az yılda bir kez)
-  **ÖLÇÜLERİ** (bakınız sayfa 35)
-  **AKIŞ DİYAGRAMI** (bakınız sayfa 35)
  - ① Normal duş
  - ② Püskürtme başlığı
-  **YEDEK PARÇALAR** (bakınız sayfa 36)
  - XXX = Renkler
  - 000 = Krom
  - 340 = Brushed Black Chrome
  - 800 = Paslanmaz Çelik-Optik
- ÖZEL AKSESUARLAR** (Teslimat kapsamına dahil değildir)
  - / Servis anahtarı #95910000 (bakınız sayfa 37)
-  **KONTROL İŞARETİ** (bakınız sayfa 37)

ARIZA	SEBEP	YARDIM
/ Batarya kullanımı ağırlaşıyor	/ Kartuş Bozulmuş ve kireçlenmiş olabilir	/ Kartuşu değiştirin
/ Batarya su damlatıyor	/ Kartuş bozuk olabilir	/ Kartuşu değiştirin
/ Döner çıkış bölgesinden su çıkışı	/ O-ring arızalı	/ O-ringi değiştirin
/ Sabitleme kutusundan su çıkışı	/ Bağlantı hortumları ana gövdeye tamamen vidalanmamış	/ Bağlantı hortumlarını elinizle sıkın
	/ Bağlantı hortumundaki O-ring arızalı	/ O-ringi değiştirin



## ⚠ INSTRUCȚIUNI DE SIGURANȚĂ

- ⚠ La montare utilizați mănuși pentru evitarea contuziunilor și tăierii mâinilor.
- ⚠ Diferențele de presiune mari între alimentarea cu apă rece și apă caldă trebuie echilibrate.

## INSTRUCȚIUNI DE MONTARE











- / Înainte de instalare verificați, dacă produsul prezintă deteriorări de transport. După instalare garanția nu acoperă deteriorările de transport și cele de suprafață.
- / Conductele și bateriile trebuie montate, spălate și verificate conform normelor în vigoare.
- / Respectați reglementările referitoare la instalare valabile în țara respectivă.

## DATE TEHNICE

Presiune de funcționare:	max. 1 MPa
Presiune de funcționare recomandată:	0,1 - 0,5 MPa
Presiune de verificare:	1,6 MPa
	(1 MPa = 10 bar = 147 PSI)
Temperatura apei calde:	max. 70°C
Temperatura recomandată a apei calde:	65°C
Dezinfecție termică:	max. 70°C/4 min

Produsul este destinat exclusiv pentru apă potabilă.

## DESCRIEREA SIMBOLURILOR

-  Nu utilizați silicon cu conținut de acid acetic
-  **REG LARE** (vezi pag. 33)  
Reglarea limitatorului de apă caldă. Nu se recomandă folosirea unui limitator de apă caldă în combinație cu un boiler instant.
-  **UTILIZARE** (vezi pag. 34)  
Hansgrohe vă recomandă, ca dimineața sau după perioade mai lungi de pauză să nu folosiți prima jumătate de litru de apă pentru băut.
-  **CURĂȚARE** (vezi pag. 38)  
În cazul unui debit redus de apă, curățați sita de impurități dintre capătul de duș și furtun.
-  **ÎNTREȚINERE** (vezi pag. 38)  
Supapele antiretur trebuie verificate regulat conform DIN EN 1717 și standardele naționale sau regionale (cel puțin o dată pe an).
-  **DIMENSIUNI** (vezi pag. 35)
-  **DIAGRAMA DE DEBIT** (vezi pag. 35)  
① jet normal  
② Cap de jet
-  **PIESE DE SCHIMB** (vezi pag. 36)  
XXX = Coduri de culori  
000 = Crom  
340 = Brushed Black Chrome  
800 = Oțel Inox
- ACCESORII OPȚIONALE** (nu este inclus în setul livrat)  
 / Cheie service #95910000 (vezi pag. 37)
-  **CERTIFICAT DE TESTARE** (vezi pag. 37)

DERANJAMENT	CAUZA	MĂSURI DE REMEDIERE
/ Bateria se mișcă dificil	/ Cartus defect din cauza depunerilor de calcar	/ Schimbați cartușul.
/ Bateria picură	/ Cartus defect	/ Schimbați cartușul.
/ Scurgere de apă în zona pipei rabatabile.	/ Inel O defect	/ Schimbați inelul O.
/ Scurgere de apă la șaftul de fixare.	/ Furtunurile de racordare nu sunt bine înșurubate în corpul bateriei.	/ Strângeți cu mâna furtunurile de racordare.
	/ Inelul O de la furtunul de racord defect	/ Schimbați inelul O.



**⚠ ΥΠΟΔΕΙΞΕΙΣ ΑΣΦΑΛΕΙΑΣ**

- ⚠ Για να αποφύγετε τραυματισμούς κατά τη συναρμολόγηση πρέπει να φοράτε γάντια.
- ⚠ Οι διαφορές της πίεσης μεταξύ της σύνδεσης κρύου και ζεστού νερού θα πρέπει να αντισταθμίζονται.

**ΟΔΗΓΙΕΣ ΣΥΝΑΡΜΟΛΟΓΗΣΗΣ**

- / Πριν τη συναρμολόγηση πρέπει να εξεταστεί το προϊόν για ζημιές μεταφοράς. Μετά την εγκατάσταση δεν αναγνωρίζονται ζημιές από τη μεταφορά ή επιφανειακές ζημιές.
- / Οι σωλήνες και η μπαταρία πρέπει να τοποθετηθούν σύμφωνα με τα ισχύοντα πρότυπα, να τεθούν υπό πίεση και να δοκιμαστούν.
- / Θα πρέπει να τηρούνται οι οδηγίες εγκατάστασης που ισχύουν σε κάθε κράτος.

**ΤΕΧΝΙΚΑ ΧΑΡΑΚΤΗΡΙΣΤΙΚΑ**

Λειτουργία πίεσης:

Συνιστώμενη λειτουργία πίεσης:

Πίεση ελέγχου:

Θερμοκρασία ζεστού νερού:

Συνιστώμενη θερμοκρασία ζεστού νερού:

Θερμική απολύμανση:

έως 1 MPa

0,1 - 0,5 MPa

1,6 MPa

(1 MPa = 10 bar = 147 PSI)

έως 70°C

65°C

έως 70°C / 4 min

Το προϊόν έχει σχεδιαστεί αποκλειστικά για πόσιμο νερό!

**ΠΕΡΙΓΡΑΦΗ ΣΥΜΒΟΛΩΝ**

Μην χρησιμοποιείτε σιλικόνη που περιέχει οξικό οξύ!



ΡΥΘΜΙΣΗ (βλ. Σελίδα 33)

Ρύθμιση του δοσομετρητή ζεστού νερού. Δεν συνιστάται η διάταξη φραγής ζεστού νερού σε συνδυασμό με ταχυθερμοσίφωνα.



ΧΕΙΡΙΣΜΟΣ (βλ. Σελίδα 34)

Η Hansgrohe συνιστά το πρωί ή μετά από μεγάλα χρονικά διαστήματα αχρησίας να μην χρησιμοποιείτε το πρώτο μισό λίτρο νερό σαν πόσιμο.



ΚΑΘΑΡΙΣΜΟΣ (βλ. Σελίδα 38)

Σε μειωμένη ροή νερού, καθαρίστε τα φίλτρα συλλογής ακαθαρσιών, που βρίσκεται ανάμεσα στον καταιονιστήρα χειρός και στο σωλήνα παροχής.



ΣΥΝΤΗΡΗΣΗ (βλ. Σελίδα 38)

Οι βαλβίδες αντεπιστροφής πρέπει να ελέγχονται τακτικά ως προς τη λειτουργία τους, σύμφωνα με το πρότυπο DIN EN 1717, σε σχέση με τους ισχύοντες εθνικούς ή τοπικούς κανόνες (το ελάχιστο μια φορά το χρόνο).



ΔΙΑΣΤΑΣΕΙΣ (βλ. Σελίδα 35)



ΔΙΑΓΡΑΜΜΑ ΡΟΗΣ (βλ. Σελίδα 35)

① Κανονική δέσμη νερού

② Δέσμη καταιονισμού



ΑΝΤΑΛΛΑΚΤΙΚΑ (βλ. Σελίδα 36)

XXX = Χρώματα

000 = Επιχρωμωμένο

340 = Brushed Black Chrome

800 = Οπτική Ανοξειδωτου Χάλυβα

ΕΙΔΙΚΑ ΑΞΕΣΟΥΑΡ (δεν περιλαμβάνεται στον παραδοτέο εξοπλισμό)



/ Κλειδί για σέρβις #95910000 (βλ. Σελίδα 37)



ΣΗΜΑ ΕΛΕΓΧΟΥ (βλ. Σελίδα 37)

ΒΛΑΒΗ	ΑΙΤΙΑ	ΔΙΟΡΘΩΣΗ
/ Σκληρή μπαταρία (μείκτης)	/ Ελαττωματικό φυσίγγιο, άλατα	/ Αλλαγή φυσιγγίου
/ Η μπαταρία στάζει	/ Ελαττωματικό φυσίγγιο	/ Αλλαγή φυσιγγίου
/ Διαρροή νερού στην περιοχή του περιστρεφόμενου ρουζουνιού.	/ Ελαττωματικός στρογγυλός δακτύλιος	/ Αλλάξτε το στρογγυλό δακτύλιο
/ Διαρροή νερού στον άξονα στερέωσης	/ Οι σωλήνες σύνδεσης δεν είναι πλήρως βιδωμένοι στο βασικό κορμό	/ Σφίξτε τους σωλήνες σύνδεσης με το χέρι
	/ Ο στρογγυλός δακτύλιος στο σωλήνα σύνδεσης είναι ελαττωματικός	/ Αλλάξτε το στρογγυλό δακτύλιο



## ⚠ VARNOSTNA OPOZORILA

- ⚠ Pri montaži je treba nositi rokavice, da se preprečijo poškodbe zaradi zmečkanja ali urezov.
- ⚠ Velike razlike v tlaku med priključkom za mrzlo in priključkom za toplo vodo je potrebno izravnati.

## NAVODILA ZA MONTAŽO











- / Pred montažo je treba izdelek preveriti glede morebitnih transportnih poškodb. Po vgradnji transportne ali površinske poškodbe ne bodo več priznane.
- / Cevi in armaturo je treba montirati, izprati in preveriti po veljavnih standardih.
- / Upoštevati je treba pravilnike o inštalacijah, ki veljajo v posamezni državi.

## TEHNIČNI PODATKI

Delovni tlak:	maks. 1 MPa
Priporočeni delovni tlak:	0,1 - 0,5 MPa
Preskusni tlak:	1,6 MPa
	(1 MPa = 10 bar = 147 PSI)
Temperatura tople vode:	maks. 70°C
Priporočena temperatura tople vode:	65°C
Termična dezinfekcija:	maks. 70°C/4 min

Proizvod je zasnovan izključno za sanitarno vodo!

## OPIS SIMBOLA

-  Ne smete uporabiti silikona, ki vsebuje ocatno kislino!
-  **JUSTIRANJE** (glejte stran 33)  
Nastavitev omejevalnika tople vode. V povezavi s pretočnimi grelniki uporaba zapore tople vode ni priporočljiva.
-  **UPRAVLJANJE** (glejte stran 34)  
Hansgrohe priporoča, da zjutraj ali po daljšem času stagnacije prvega pol litra vode ne uporabite kot pitno vodo.
-  **ČIŠČENJE** (glejte stran 38)  
Ob zmanjšanem pretoku vode očistite filter med ročno prho in gibko cevjo.
-  **VZDRŽEVANJE** (glejte stran 38)  
Delovanje protipovratnega ventila je potrebno v skladu z DIN EN 1717 in skladno z državnimi in regionalnimi določili redno testirati (najmanj enkrat letno).
-  **MERE** (glejte stran 35)
-  **DIAGRAM PRETOKA** (glejte stran 35)
  - ① Normalen curek
  - ② Pršilni curek
-  **REZERVNI DELI** (glejte stran 36)
  - XXX = Barve
  - 000 = Krom
  - 340 = Brushed Black Chrome
  - 800 = Videz legiranega Jekla
- POSEBEN PRIBOR** (Ni vključeno)
  -  / Servisni ključ #95910000 (glejte stran 37)
-  **PRESKUSNI ZNAK** (glejte stran 37)

NAPAKA	VZROK	POMOČ
/ Težko premikanje armature	/ Pokvarjen vložek, poapneno	/ Zamenjajte vložek
/ Iz armature kaplja	/ Pokvarjen vložek	/ Zamenjajte vložek
/ Uhajanje vode ob vrtljivem izlivu	/ Obročno tesnilo je pokvarjeno	/ Zamenjajte obročno tesnilo
/ Uhajanje vode ob pritrdilnem nastavku	/ Priključne cevi niso popolnoma privijačene v osnovno ogrodje	/ Ročno zatisnite priključne cevi
	/ Obročna tesnila priključnih gibkih cevi so pokvarjena	/ Zamenjajte obročno tesnilo



**△ OHUTUSJUHISED**

- △ Kandke paigaldamisel muljumis- ja löikevigastuste vältimiseks kindaid.
- △ Kui külma ja kuuma vee ühenduste surve on väga erinev, tuleb need tasakaalustada.

**PAIGALDAMISJUHISED**











- / Enne paigaldamist tuleb toodet kontrollida transpordikahjustuste osas. Pärast paigaldamist ei tunnustata enam transpordi- või pinnakahjustuste kaebuseid.
- / Voolikute ja segisti paigaldamisel, loputamisel ja kontrollimisel tuleb lähtuda kehtivatest normatiividest.
- / Vastavas riigis kehtivaid paigalduseeskirju tuleb järgida.

**TEHNILISED ANDMED**

Töörõhk	maks. 1 MPa
Soovitav töörõhk:	0,1 - 0,5 MPa
Kontrollsurve:	1,6 MPa (1 MPa = 10 baari = 147 PSI)
Kuuma vee temperatuur:	maks. 70°C
Soovitav kuuma vee temperatuur:	65°C
Termiline desinfektsioon:	maks. 70°C/4 min

Toode on ette nähtud eranditult joogivee jaoks!

**SÜMBOLITE KIRJELDUS**

-  Ärge kasutage äädikhapet sisaldavat silikoonil
-  **REGULEERIMINE** (vt lk 33)  
Sooja vee piirangu seadistamine. Ühenduses boileritega ei ole sooja vee blokeeringu soovitatav.
-  **KASUTAMINE** (vt lk 34)  
Hansgrohe soovib mitte kasutada esimest poolt liitrit hommikuti või pärast pikemat seisakuaega joogiveena.
-  **PUHASTAMINE** (vt lk 38)  
Kui vee läbivool on vähenenud, puhastage ära käsiduši ja vooliku vaheline filter.
-  **HOOLDUS** (vt lk 38)  
Tagasilöögiklappide toimimist tuleb kooskõlas riiklike ja regionaalsete määrustega regulaarselt kontrollida vastavalt standardile DIN EN 1717 (vähemalt kord aastas).
-  **MÕÕTUDE** (vt lk 35)
-  **LÄBIVOOLUDIAGRAMM** (vt lk 35)  
① tavajuga  
② Duši juga
-  **VARUOSAD** (vt lk 36)  
XXX = Värvid  
000 = Kroom  
340 = Brushed Black Chrome  
800 = Roostevaba Optik
- SPETSIAALNE LISAVARUSTUS** (ei sisaldu komplektis)  
 / Hooldusvõi #95910000 (vt lk 37)
-  **KONTROLLSERTIFIKAAT** (vt lk 37)

RIKE	PÕHJUS	LAHENDUS
/ Segisti käib raskelt	/ Tööelement on katkine, lubjastunud	/ Vahetage tööelement
/ Segisti tilgub	/ Tööelement on katkine	/ Vahetage tööelement
/ Veeleke pööratavas jooksutorus	/ O-rõngastihend on katki	/ Vahetage O-rõngastihend
/ Veeleke kinnituse juures	/ Ühendusvoolikud ei ole korralikult põhikorpuse külge kruvitud	/ Kruvige ühendusvoolikud käega kinni
	/ Ühendusvoolikute O-rõngastihendid katki	/ Vahetage O-rõngastihend





## ⚠ DROŠĪBAS NORĀDES

- ⚠ Montāžas laikā, lai izvairītos no saspiedumiem un iegriezumiem, nepieciešams nēsāt cimdus.
- ⚠ Jāizlīdzina spiediena atšķirības starp aukstā un karstā ūdens pievadiem.

## NORĀDĪJUMI MONTĀŽAI

- / Pirms montāžas nepieciešams pārbaudīt, vai produktam transportēšanas laikā nav radušies bojājumi. Pēc iebūvēšanas bojājumi, kas radušies transportēšanas laikā, vai virsmas bojājumi netiek atzīti.
- / Cauruļvadi un armatūra ir jāuzstāda, jāizskalo un jāpārbauda saskaņā ar spēkā esošajiem standartiem.
- / Jāievēro attiecīgās valstīs spēkā esošās montāžas prasības.

## TEHNISKIE DATI

Darba spiediens:	maks. 1 MPa
Ieteicamais darba spiediens:	0,1 - 0,5 MPa
Pārbaudes spiediens:	1,6 MPa (1 MPa = 10 bar = 147 PSI)
Karstā ūdens temperatūra:	maks. 70°C
Ieteicamā karstā ūdens temperatūra:	65°C
Termiskā dezinfekcija :	maks. 70°C / 4 min

Izstrādājums ir paredzēts tikai dzeramajam ūdenim!

## SIMBOLU NOZĪME

-  Neizmantojot silikonu, kas satur etiķskābi!
-  **IEREGULĒŠANA** (skat. lpp. 33)  
Karsta ūdens ierobežotāja regulēšana. Kopā ar caurteces sildītājiem nav ieteicams izmantot ūdens bloķētāju.
-  **LIETOŠANA** (skat. lpp. 34)  
Hansgrohe iesaka no rīta vai pēc ilgākiem pārtraukumiem nelietot pirmo puslitru ūdens dzeršanai.
-  **TĪRĪŠANA** (skat. lpp. 38)  
Nepietiekamas ūdens plūsmas gadījumā jāiztīra filtrs, kas atrodas starp rokas dušu un šļūteni
-  **APKOPE** (skat. lpp. 38)  
Regulāri jāpārbauda pretvārsta funkcija saskaņā ar DIN EN 1717 saistībā ar nacionālajiem vai vietējiem noteikumiem (vismaz vienreiz gadā).
-  **IZMĒRUS** (skat. lpp. 35)
-  **CAURPLŪDES DIAGRAMMA** (skat. lpp. 35)
  - ① Standarta strūkļa
  - ② Dušas strūkļa
-  **REZERVES DAĻAS** (skat. lpp. 36)
  - XXX = Krāsu kodi
  - 000 = Hroma
  - 340 = Brushed Black Chrome
  - 800 = Tērauda
- SPECIĀLI AKSESUĀRI** (komplektā netiek piegādāts)
  - / Apkopes atslēga #95910000 (skat. lpp. 37)
-  **PĀRBAUDES ZĪME** (skat. lpp. 37)

## TRAUCĒJUMS

- / Jaucējkrāns smagi grozāms
- / Jaucējkrāns pil
- / Ūdens noplūde grozāmās iztekas rajonā
- / Ūdens noplūde pie nostiprinājuma

## IEMESLS

- / Bojāta kartuša, aizkalkojusies
- / Bojāta kartuša
- / Bojāts O-gredzens
- / Pieslēguma šļūtenes nav līdz galam ieskrūvētas pamatelementā
- / Bojāti pieslēguma šļūteņu O-gredzeni

## BOJĀJUMU NOVĒRŠANA

- / Nomainīt kartušu
- / Nomainīt kartušu
- / Nomainīt O-gredzenu
- / Pieslēguma šļūtenes ar roku pievilkt stingrāk
- / Nomainīt O-gredzenu



## ⚠ SIGURNOSNE NAPOMENE

- ⚠ Prilikom montaže se radi sprečavanja prignječenja i posekوتا moraju nositi rukavice.
- ⚠ Velika razlika u pritisku između vruće i hladne vode mora biti izbalansirana.

## INSTRUKCIJE ZA MONTAŽU

- / Pre montaže se mora proveriti da li je proizvod oštećen pri transportu. Nakon ugradnje se ne priznaju nikakve reklamacije koje se odnose na površinska i transportna oštećenja.
- / Vodovi i armatura moraju biti postavljeni, isprani i testirani prema važećim normama.
- / Treba se pridržavati propisa koji u određenim zemljama važe za instalacije.

## TEHNIČKI PODACI

Radni pritisak:	maks. 1 MPa
Preporučeni radni pritisak:	0,1 - 0,5 MPa
Probni pritisak:	1,6 MPa (1 MPa = 10 bar = 147 PSI)
Temperatura vruće vode:	maks. 70°C
Preporučena temperatura vruće vode:	65°C
Termička dezinfekcija:	maks. 70°C / 4 min

Proizvod je koncipiran isključivo za pijaću vodu!

## OPIS SIMBOLA



Nemojte koristiti silikon koji sadrži sirćetnu kiselinu!



**PODEŠAVANJE** (vidi stranu 33)

Podešavanje ograničivača tople vode. U kombinaciji sa protočnim bojlerima ne preporučuje se primena sistema za blokiranje dotoka tople vode.



**RUKOVANJE** (vidi stranu 34)

Hansgrohe preporučuje da ujutru ili nakon dužeg nekorisćenja prvih pola litre vode ne koristite za piće.



**ČIŠĆENJE** (vidi stranu 38)

Ukoliko ne izlazi dovoljno vode, moguće je da se na mrežici za hvatanje prljavštine, između glave i creva tuša, nakupila prljavština. Očistite filter.



**ODRŽAVANJE** (vidi stranu 38)

Ispravno funkcionisanje nepovratnog ventila se mora redovno proveravati prema standardu DIN EN 1717 i u skladu s važećim nacionalnim ili regionalnim propisima (najmanje jednom godišnje).



**MERE** (vidi stranu 35)



**DIJAGRAM PROTOKA** (vidi stranu 35)

- ① Normalni mlaz
- ② mlaz



**REZERVNI DELOVI** (vidi stranu 36)

XXX = Oznake boja  
000 = Hrom  
340 = Brushed Black Chrome  
800 = Dezen Plemeniti Čelik

**POSEBAN PRIBOR** (Nije sadržano u isporuci)



/ Servisni ključ #95910000 (vidi stranu 37)



**ISPITNI ZNAK** (vidi stranu 37)

SMETNJA	UZROK	POMOĆ
/ Ručica se zaglavila	/ Neispravna kartuša, nataloženi kamenac	/ Zamenite kartušu
/ Slavina kaplje	/ Neispravna kartuša	/ Zamenite kartušu
/ Voda izlazi u zaglobu slavine	/ O prsten je neispravan	/ Zamenite O prsten
/ Voda izlazi na delu gde je slavina učvršćena	/ Priključna creva nisu potpuno učvršćena na telo	/ Priključna creva učvrstite rukom
	/ O prstenovi priključnih creva su neispravni	/ Zamenite O prsten



## ⚠ SIKKERHETSHENVISNINGER

- ⚠ Bruk hansker under montasjen for å unngå klem- og kuttskader.
- ⚠ Store trykkdifferanser mellom kaldt- og varmtvannstilkoblinger skal utlignes.

## MONTAGEHENVISNINGER

- / Før montasjen skal produktet sjekkes for transportskader. Etter monteringen aksepteres ikke noen transport- eller overflateskader.
- / Ledningene og armaturen skal monteres, spyles og sjekkes iht. de gyldige normer.
- / Gjeldende retningslinjer for rørleggerarbeid i de enkelte land skal følges.

## TEKNISKE DATA

Driftstrykk	maks. 1 MPa
Anbefalt driftstrykk:	0,1 - 0,5 MPa
Prøvetrykk	1,6 MPa (1 MPa = 10 bar = 147 PSI)
Varmtvannstemperatur	maks. 70°C
Anbefalt temperatur for varmt vann	65°C
Termisk desinfisering:	maks. 70°C / 4 min

Produktet er utelukkende designet for drikkevann!

## SYMBOLBESKRIVELSE

-  Ikke bruk silikon som inneholder eddiksyre!
-  **JUSTERING** (se side 33)  
Innstilling av varmtvannsbegrensning. I forbindelse med gjennomstrømningsvarmere er det ikke anbefalt å bruke en varmtvannssperre.
-  **BETJENING** (se side 34)  
Om morgen og etter lengre stagnasjonstider anbefaler Hansgrohe å ikke bruke den første halvliteren som drikkevann.
-  **RENGJØRING** (se side 38)  
Ved forminsknet vanngjennomstrømning skal smussfilteret mellom hånddusj og slangen renses.
-  **VEDLIKEHOLD** (se side 38)  
Funksjonen til returløpssperren skal iht. DIN EN 1717 og i samsvar med de nasjonale og lokale forskrifter sjekkes regelmessig (minst en gang i året).
-  **MÅL** (se side 35)
-  **GJENNOMSTRØMNINGSDIAGRAM** (se side 35)
  - ① Normalstråle
  - ② Dusjstråle
-  **SERVICEDELER** (se side 36)
  - XXX = Fargekode
  - 000 = Krom
  - 340 = Brushed Black Chrome
  - 800 = Rustfritt Stål Optikk
- EKSTRATILBEHØR** (ikke med i leveransen)
  - / Servicenøkkel #95910000 (se side 37)
-  **PRØVEMERKE** (se side 37)

FEIL	ÅRSAK	FEILRETTELSE
/ Armatur ikke lett bevegelig	/ Kartusj defekt, forkalkning	/ Kartusj byttes
/ Armatur drypper	/ Kartusj defekt	/ Kartusj byttes
/ Vannlekkasje i området for svingutløpet	/ O-ring defekt	/ O-ring byttes
/ Vannlekkasje på festeskift	/ Tilkoblingsslanger ikke skrudd helt inn i basiselement	/ Tilkoblingsslanger trekkes fast fra hånd
	/ O-ring på tilkoblingsslangen defekt	/ O-ring byttes



**⚠ УКАЗАНИЯ ЗА БЕЗОПАСНОСТ**

- ⚠ При монтажа трябва да се носят ръкавици, за да се избегнат наранявания поради притискане или порязване.
- ⚠ Големите разлики в налягането между изводите за студената и топлата вода трябва да се изравняват.

**УКАЗАНИЯ ЗА МОНТАЖ**









- / Преди монтажа продуктът трябва да се провери за транспортни щети. След монтажа не се признават транспортни или повърхностни щети.
- / Тръбопроводите и арматурата трябва да се монтират, промият и проверят в съответствие с валидните норми.
- / Трябва да бъдат спазвани валидните в съответните страни предписания за инсталиране.

**ТЕХНИЧЕСКИ ДАННИ**

Работно налягане:	макс. 1 МПа
Препоръчително работно налягане:	0,1 - 0,5 МПа
Контролно налягане:	1,6 МПа (1 МПа = 10 bar = 147 PSI)
Температура на горещата вода:	макс. 70°C
Препоръчителна температура на горещата вода:	65°C
Термична дезинфекция:	макс. 70°C/4 мин

Продуктът е разработен само за питейна вода!

**ОПИСАНИЕ НА СИМВОЛИТЕ**

-  Не използвайте силикон, съдържащ оцетна киселина!
-  ЮСТИРАНЕ (вижте стр. 33)  
Настройка на ограничителя за топлата вода. Във връзка с проточни нагреватели не се препоръчва блокировка за топлата вода
-  ОБСЛУЖВАНЕ (вижте стр. 34)  
Hansgrohe препоръчва, сутрин и след по-продължително спиране първият половин литър да не се използва като питейна вода.
-  ПОЧИСТВАНЕ (вижте стр. 38)  
При намалена пропускателна способност на водата почистете цедката за улавяне на замърсявания между изтеглящия се разпръсквател за кухненската мивка и маркуча.
-  ПОДДРЪЖКА (вижте стр. 38)  
Съгласно DIN EN 1717 функционирането на приспособленията за предотвратяване на обратния поток трябва редовно да се проверява в съответствие с националните или регионални изисквания (поне веднъж годишно).
-  РАЗМЕРИ (вижте стр. 35)
-  ДИАГРАМА НА ПОТОКА (вижте стр. 35)
  - ① Нормална струя
  - ② Разпръскваща струя
-  СЕРВИЗНИ ЧАСТИ (вижте стр. 36)
  - XXX = Цветово кодиране
  - 000 = Хром
  - 340 = Brushed Black Chrome
  - 800 = Оптика На благородна Стомана
- СПЕЦИАЛНИ ПРИНАДЛЕЖНОСТИ (не се съдържа в обема на доставка)
  - / Сервизен ключ #95910000 (вижте стр. 37)
-  КОНТРОЛЕН ЗНАК (вижте стр. 37)

НЕИЗПРАВНОСТ	ПРИЧИНА	ПОМОЩ
/ Трудно подвижна арматура	/ Дефектна гилза, покрита с варовик	/ Сменете гилзата
/ Арматурата капе	/ Дефектна гилза	/ Сменете гилзата
/ Избиване на вода в областта на завъртащия се изходящ накрайник	/ Дефектен О-образен пръстен	/ Смяна на О-образен пръстен
/ Избиване на вода от закрепващата шийка	/ Свързващите маркучи не са напълно завинтени в основното тяло	/ Затегнете на ръка свързващите маркучи
	/ Дефектен О-образен пръстен на свързващия маркуч	/ Смяна на О-образен пръстен



## ⚠ UDHËZIME SIGURIE

- ⚠ Për të evituar lëndimet e pickimeve ose të prerjeve gjatë procesit të montimit duhet që të vishni doreza.
- ⚠ Ndryshimet e mëdha të presionit mes lidhjeve të ujit të ftohtë dhe atij të ngrohtë duhen ekuilibruar.

## UDHËZIME PËR MONTIMIN









- / Përpara montimit duhet që produkti të kontrollohet për dëmtime nga transporti. Pas instalimit nuk do të njihet asnjë dëmtim nga transporti ose dëmtim i sipërfaqes.
- / Tubacionet dhe rubinetet duhet që të montohen, të shpëlahen dhe të kontrollohen sipas standardeve në fuqi
- / Duhet të respektohen linjat udhëzuese të instalimit, të vlefshme për vendet respektive.

## TË DHËNA TEKNIKE

Presioni gjatë punës	maks. 1 MPa
Presioni i rekomanduar:	0,1 - 0,5 MPa
Presioni për provë:	1,6 MPa
	(1 MPa = 10 bar = 147 PSI)
Temperatura e ujit të ngrohtë	maks. 70°C
Temperatura e rekomanduar e ujit të ngrohtë:	65°C
Dezinfektim Termik:	maks. 70°C/4 min

Produkti është projektuar ekskluzivisht për ujë të pijshëm!

## PËRSHKRIMI I SIMBOLIT

-  Mos përdorni silikon që në përbërje ka acid acetik.
-  **J U S T I M I** (shih faqen 33)  
Rregullimi i kufizimit me ujë të nxehtë. Nje kombinim me një bojler ujit nuk është i rekomanduar.
-  **P Ë R D O R I M I** (shih faqen 34)  
Hansgrohe rekomandon që në mëngjes ose pas periudhave të gjata që gjysmë litri i parë mos të pihet
-  **P A S T R I M I** (shih faqen 38)  
Nëse pakësohet vëllimi i ujit, atëherë pastroni sitën për mbledhjen e ndotjeve që ndodhet mes spërkatësës në formë grushti dhe tubit.
-  **M I R Ë M B A J T J A** (shih faqen 38)  
Pënguesit e rrjedhjes në drejtim të kundërt duhen kontrolluar rregullisht në bazë të normave DIN EN 1717 konform normave nacionale dhe regjionale (së paku një herë në vit).
-  **P Ë R M A S A T** (shih faqen 35)
-  **D I A G R A M I I Q A R K U L L I M I T** (shih faqen 35)  
① Curril normal  
② currila/trezja sperkatese
-  **P J E S Ë T E S E R V I S I T** (shih faqen 36)  
XXX = Kodimi me anë të ngjyrave  
000 = Krom  
340 = Brushed Black Chrome  
800 = Optikë Çeliku
- P A J I S J E T Ë P O S A Ç M E** (nuk përfshihet në vëllimin e furnizimit)  
 / Çelësi i servisit #95910000 (shih faqen 37)
-  **S H E N J A E K O N T R O L L I T** (shih faqen 37)

DEMTIM	SHKAKU	NDIHME
/ Armatura punon rende	/ Kartusha me defekt, me kalk	/ Kembeni kartushen
/ Armatura pikon	/ Kartusha me defekt	/ Kembeni kartushen
/ Derdhje e ujit në zonën e daljes	/ Unaza O me defekt	/ Kembeni unazen O
/ Dalje e ujit ne cilindrin fiksues	/ Tubat e lidhjes jo komplet te vidhosur ne karkasen baze	/ Shtrengojini manualisht tubat e lidhur
	/ Unaza O tek tubi lidhes me defekt	/ Kembeni unazen O



## وصف الرمز

هام! لا تستخدم السليكون الذي يحتوي على أحماض!



## الضبط (راجع صفحة 33)



ضبط تحديد المياه الدافئة. لا ينصح باستخدام محدّد المياه الدافئة مع سخان المياه الوقتي.

## التشغيل (راجع صفحة 34)



تنصح شركة هانزجرروي Hansgrohe بعدم استخدام أول نصف لتر من الماء لغرض الشرب وذلك في الصباح أو بعد توقف استخدام الماء لفترات طويلة نسبياً.

## التنظيف (راجع صفحة 38)



إذا انخفض معدل تدفق المياه، قم بتنظيف المرشح (الفلتر) الموجود بين الخرطوم والرشاش اليدوي.

## الصيانة (راجع صفحة 38)



يجب فحص صمام عدم الرجوع بصفة منتظمة حسب المواصفة DIN EN 1717 وذلك طبقاً للوائح الوطنية أو الإقليمية (مرة واحد سنوياً على الأقل).

## أبعاد (راجع صفحة 35)



## رسم للصراف (راجع صفحة 35)



① رشاش عادي  
② الدش

## قطع الغيار (راجع صفحة 36)



XXX = الألوان  
000 = كروم  
Brushed Black Chrome = 340  
800 = مظهر الإستنليس ستيل

## ملحقات خاصة (غير مدرج مع المحتويات المسلمة)

/ مفتاح الخدمة #95910000 (راجع صفحة 37)



## شهادة اختبار (راجع صفحة 37)



## تنبيهات الأمان

⚠ يجب إرتداء قفازات لليد أثناء التركيب لتجنب حدوث أخطار الإنحشار أو الجروح.

⚠ يجب أن يكون تيار الماء الساخن والماء البارد متعادلين في الضغط.

## تعليمات التركيب

/ قبل القيام بعملية التركيب، يجب فحص المنتج للتأكد من خلوه من أية تلفيات ناتجة عن النقل. بعد القيام بعملية التركيب، لن يتم الاعتراف بوجود أية تلفيات سطحية أو تلفيات ناتجة عن عملية النقل.

/ يجب تركيب وغسيل واختبار التوصيلات وخلطات المياه طبقاً للمعايير السارية.

/ يجب مراعاة القواعد الخاصة بالتركيب وأعمال السباكة وفقاً للوائح الخاصة بكل بلد.

## المواصفات الفنية

ضغط التشغيل:

ضغط التشغيل الموصى به:

ضغط الاختبار:

درجة حرارة الماء الساخن:

درجة الحرارة الموصى بها للماء الساخن:

تعميم حراري:

المنتج مخصص فقط لماء الشرب!

الحد الأقصى 1 ميجابسكال

0,5 - 0,1 ميجابسكال

1,6 ميجابسكال

(1 ميجابسكال = 10 بار = 147 PSI)

الحد الأقصى 70°C

65°C

الحد الأقصى 70°C / 4 الدقيقة

العطل	السبب	العلاج والإصلاح
/ الخلاط ثقيل الحركة	/ الخرطوشة تالفة، تراكم عليها الجير	/ قم بتغيير الخرطوشة
/ تساقط قطرات مياه من الخلاط	/ الخرطوشة تالفة	/ قم بتغيير الخرطوشة
/ خروج الماء من منطقة الخروج المتأرجح	/ الحلقة الدائرية تالفة	/ قم بتغيير الحلقة الدائرية
/ خروج الماء من جزء التثبيت	/ خرطوم التوصيل ليست مربوطة في الجزء الرئيسي بشكل كامل	/ اربط خرطوم التوصيل بيدك
	/ الحلقة الدائرية الخاصة بخرطوم التوصيل تالفة	/ قم بتغيير الحلقة الدائرية



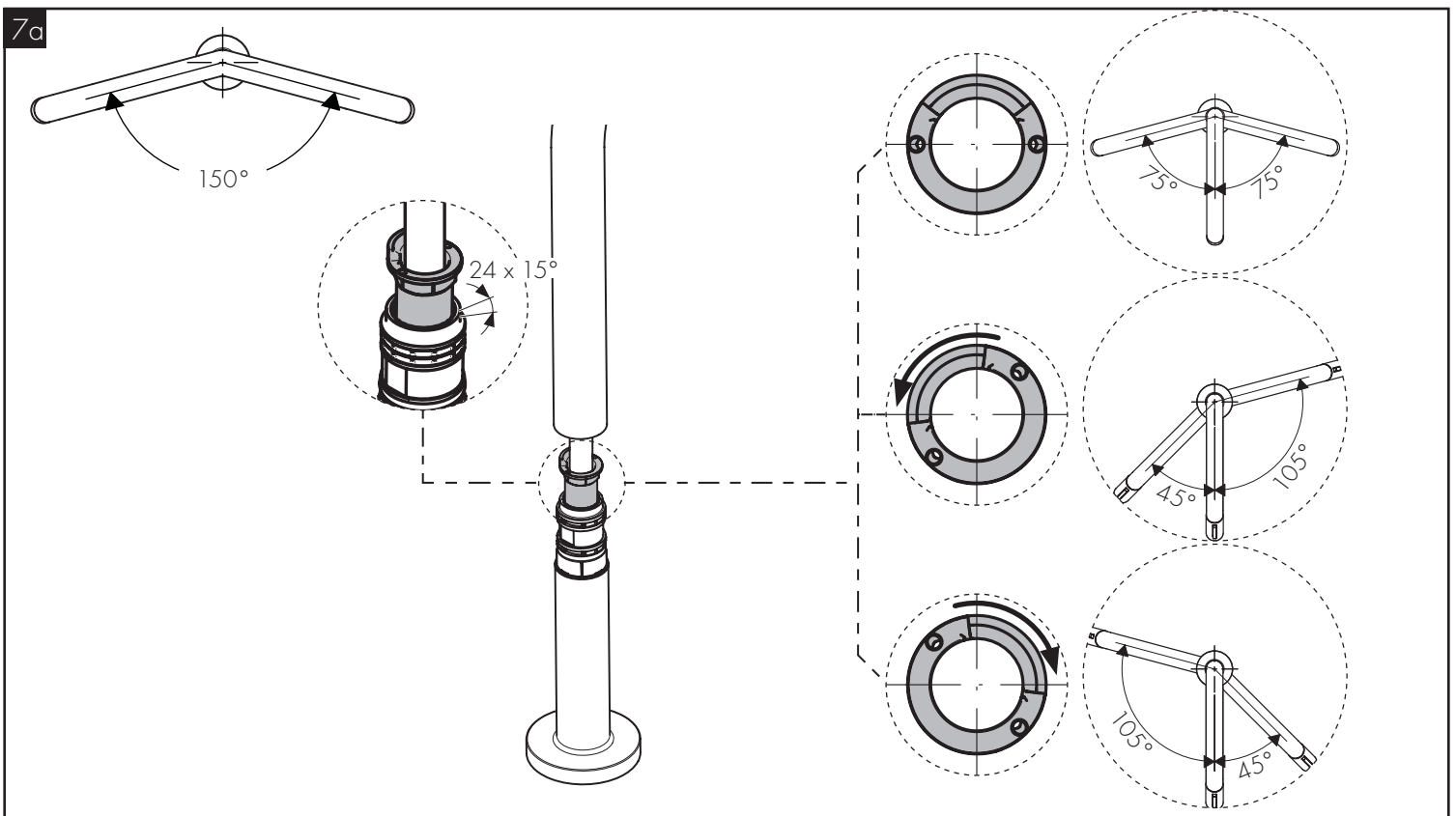
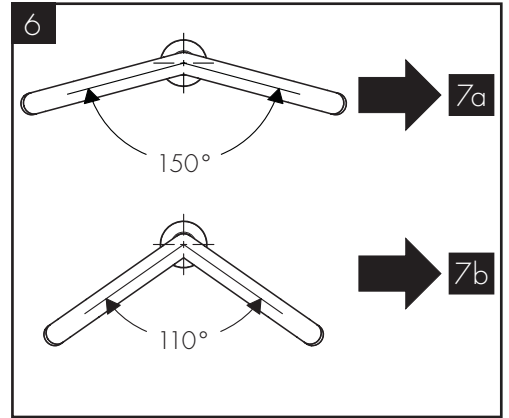
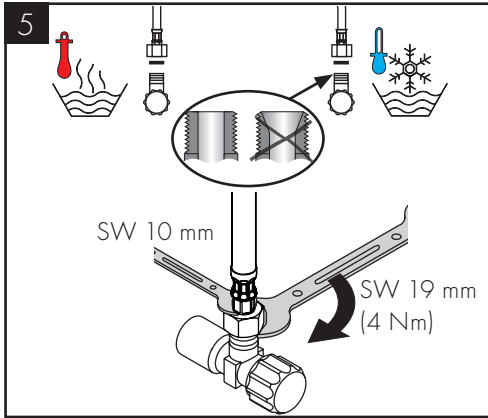
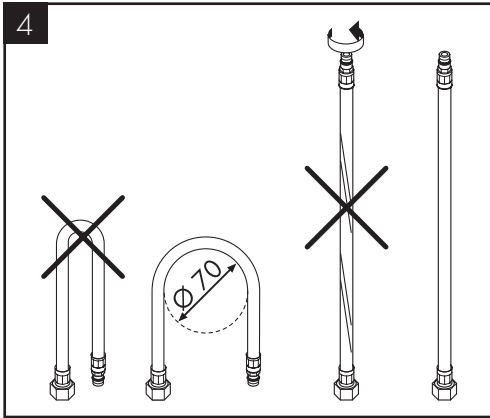
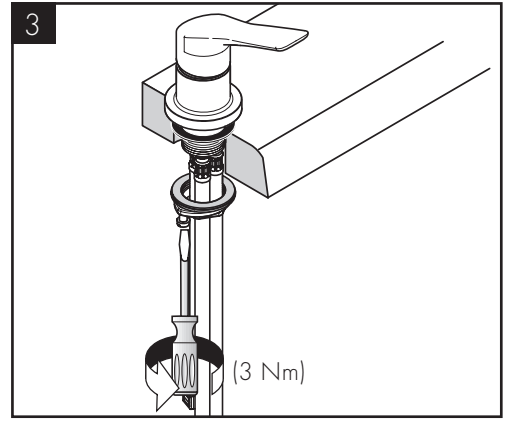
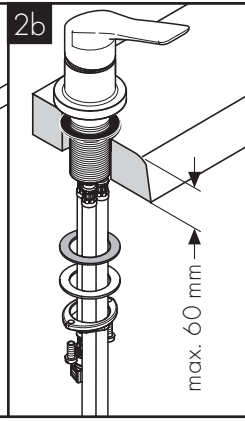
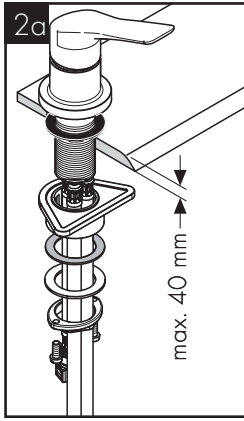
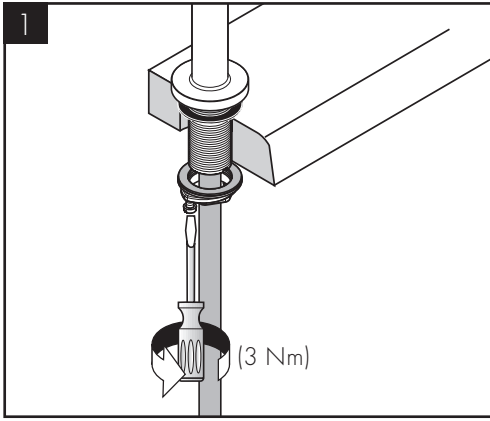

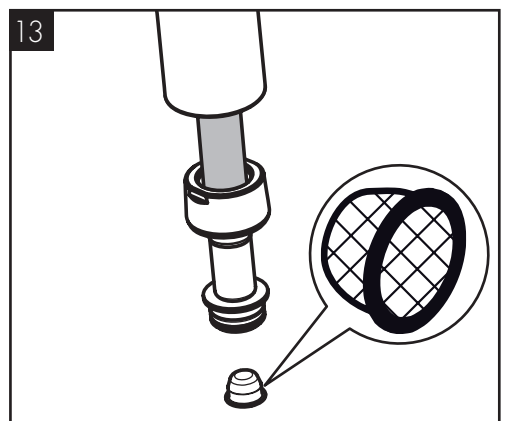
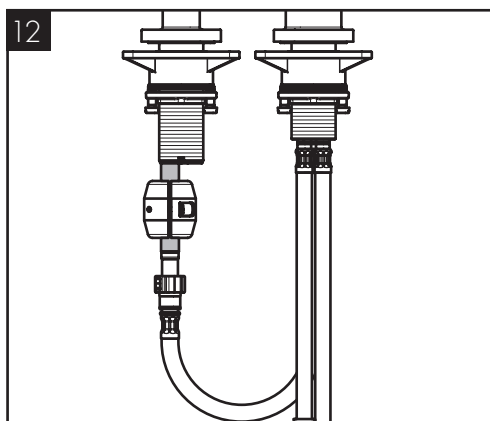
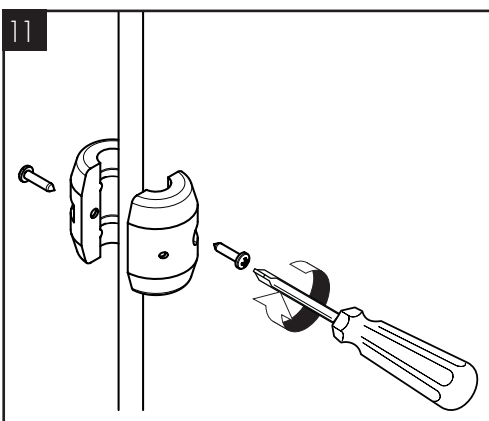
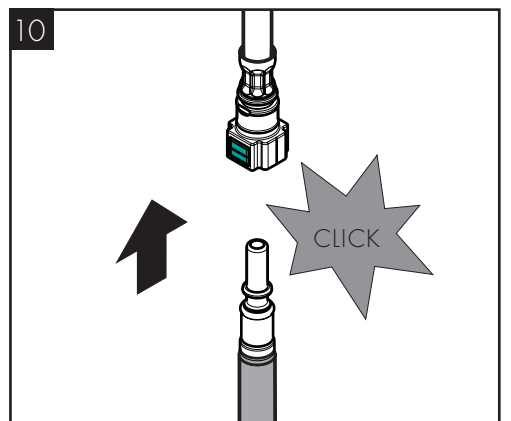
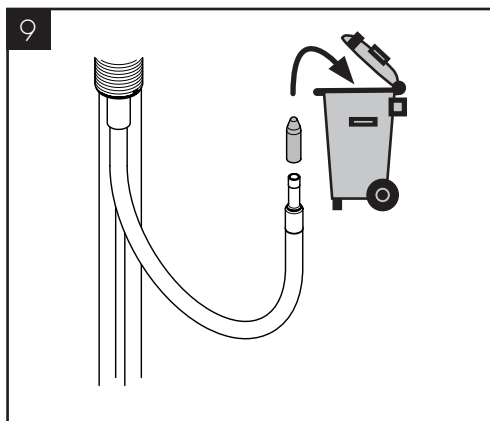
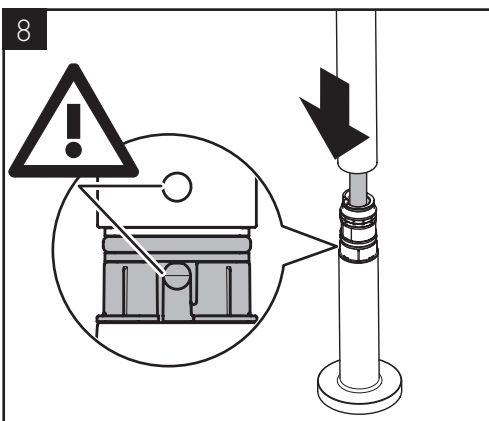
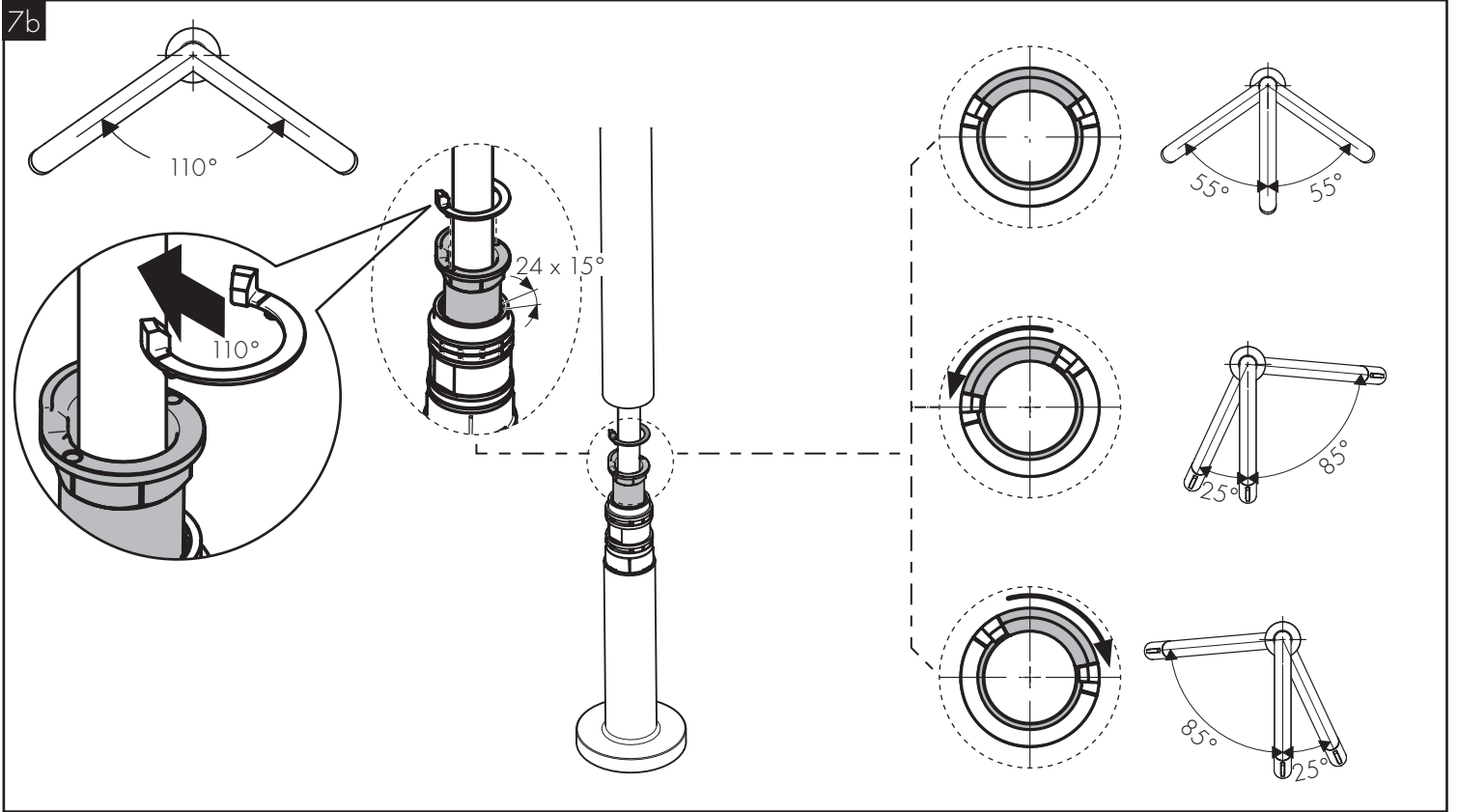



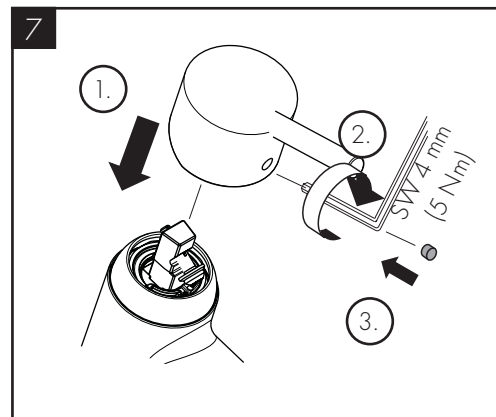
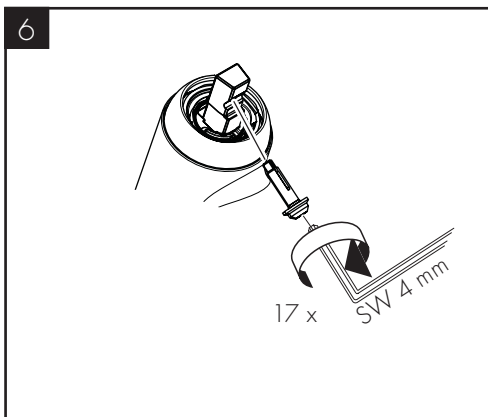
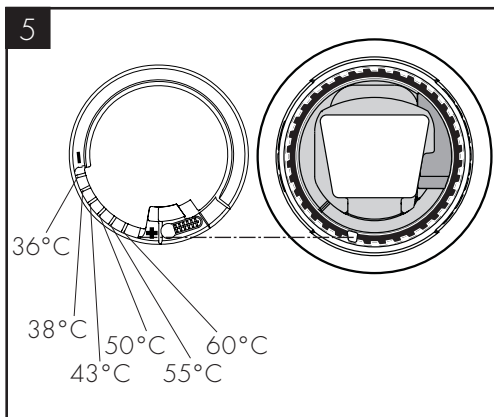
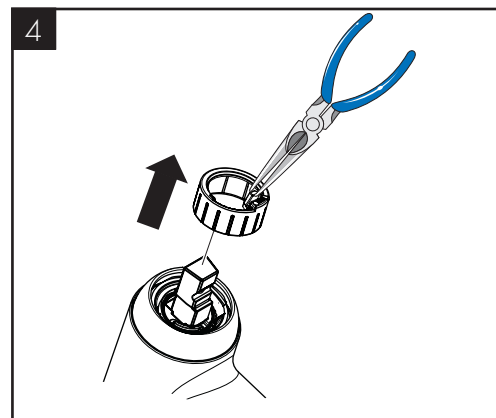
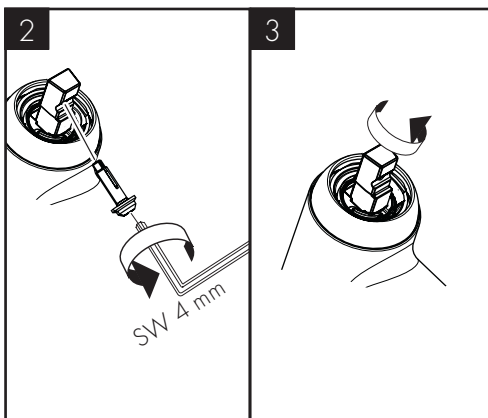
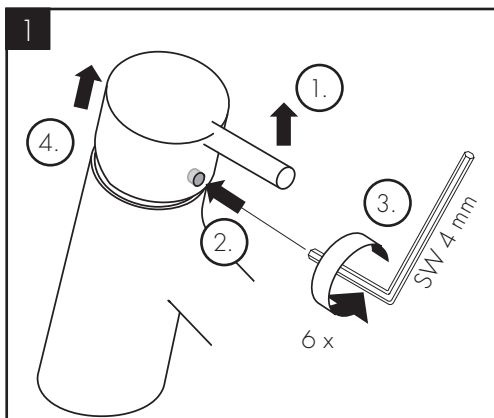
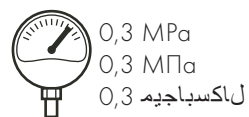
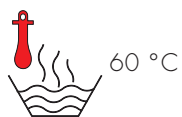
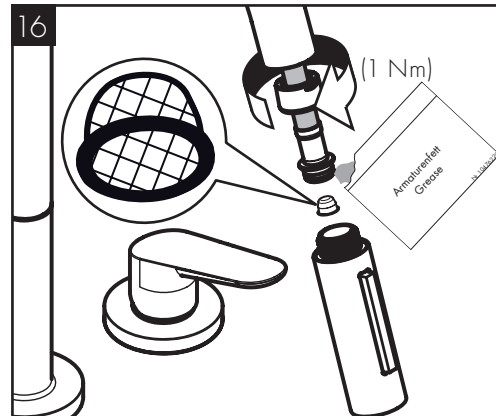
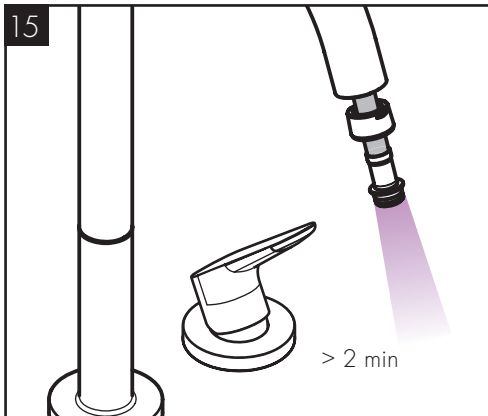
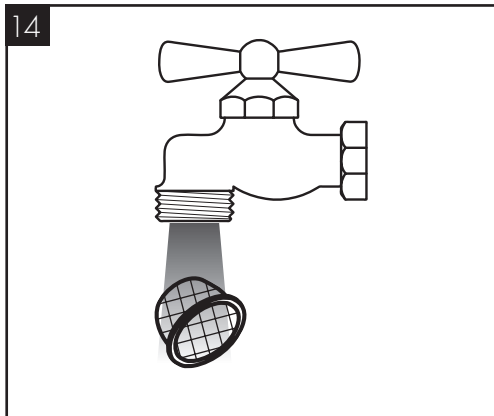

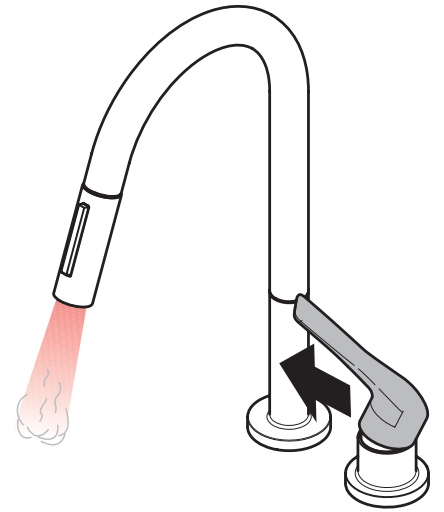
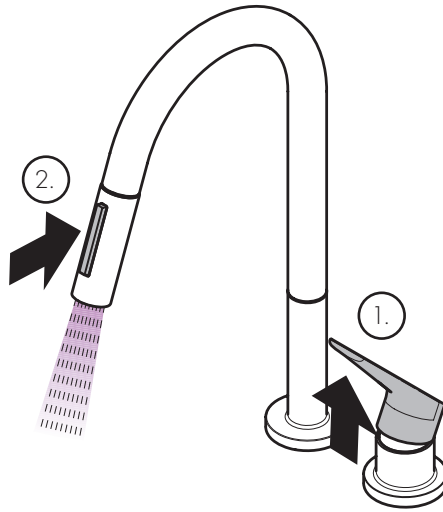
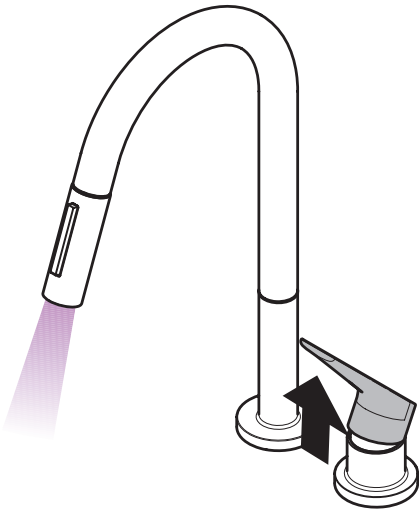

öffnen/ouvert/open/aperto/abierto/open/åbne/abrir/otworzyć/otevřít/otvorit/开/открыть/nyitás/avaaminen/öppna/atidaryti/Otvoranje/açmak/deschide/ανοικτό/odpreti/avage/atvērt/otvoriti/årne/отваряне/hape/فتح

warm/chaud/hot/caldo/caliente/warm/varmt/quente/ciepła/teplá/teplá/热/горячая/meleg/lämmin/varmt/karštas/Vruća voda/sıcak/cald/ζεστό/toplo/kuum/karsts/topla/varm/топло/i ngrohtë/ساخن

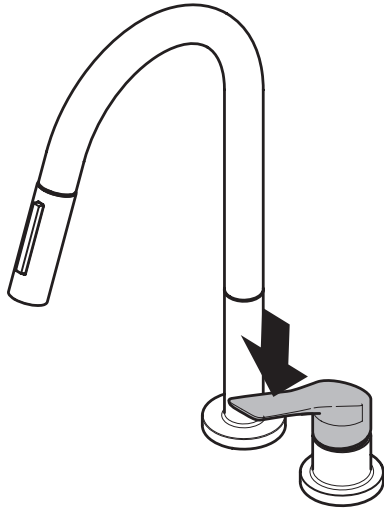

schließen/fermé/close/chiudere/cerrar/sluiten/lukke/fechar/zamknąć/zavřít/uzavrieť/关/закреть/bezárás/sulkeminen/stänga/uždaryti/Zatvaranje/karatmak/ínchide/κλειστό/zapreti/sulgege/aizvērt/zatvori/lukke/zatvarяне/mbylle/إغلاق

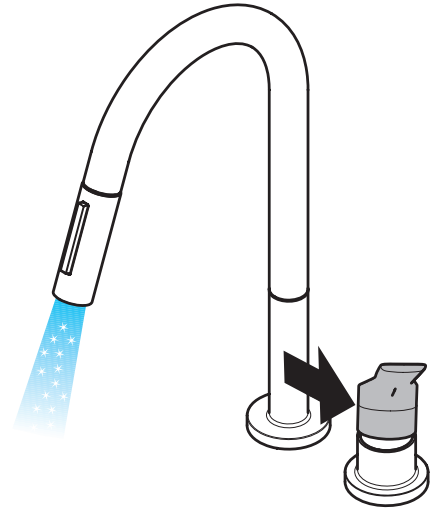

kalt/froid/cold/freddo/frío/koud/koldt/fria/zimna/studená/studená/冷/холодная/hideg/kylmä/kallt/šaltas/Hladno/soğuk/rece/κρύο/mrzlo/külm/auksts/hladno/kaldt/студено/i frohtë/بارد



AXOR Citterio M

34822000 / 34822340 / 34822800

AXOR Citterio M Eco

34824000

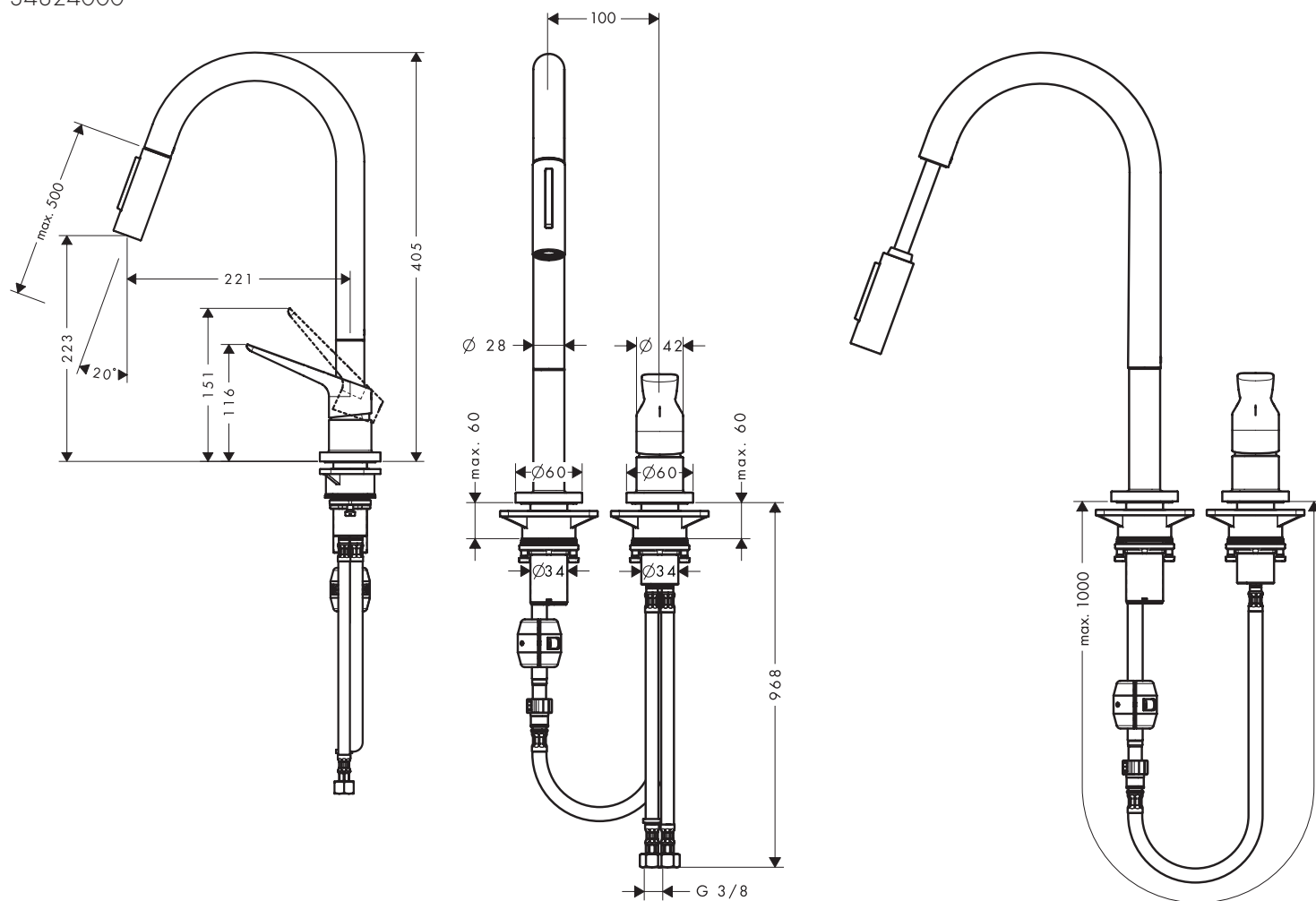

AXOR Citterio M

34822000 / 34822340 / 34822800

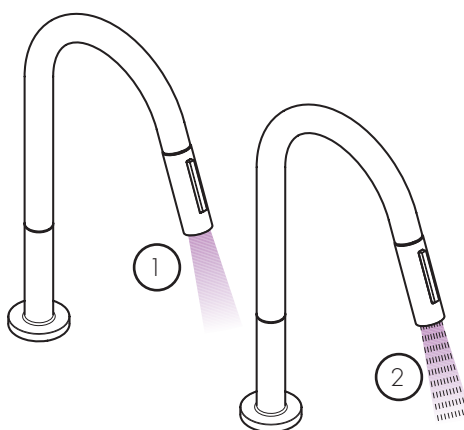
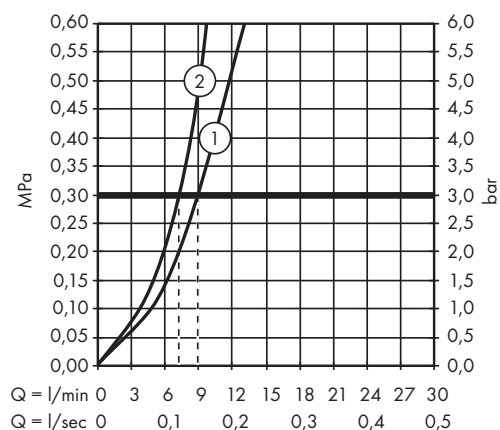

AXOR Citterio M Eco

34824000

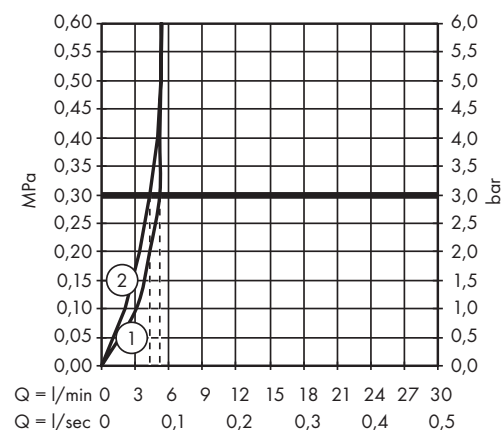



# AXOR Citterio M

34822000 / 34822340 / 34822800

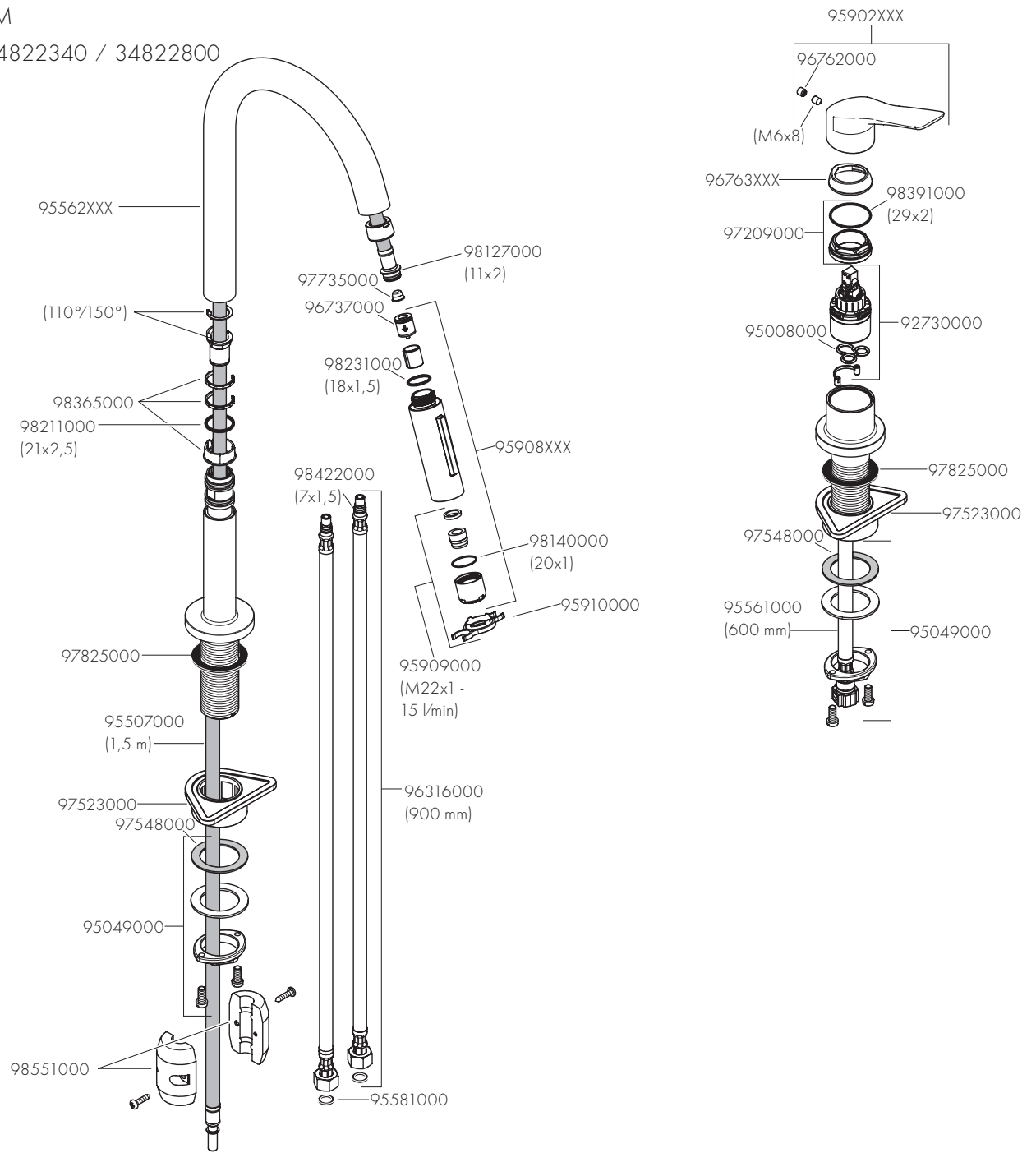



AXOR Citterio M Eco  
34824000

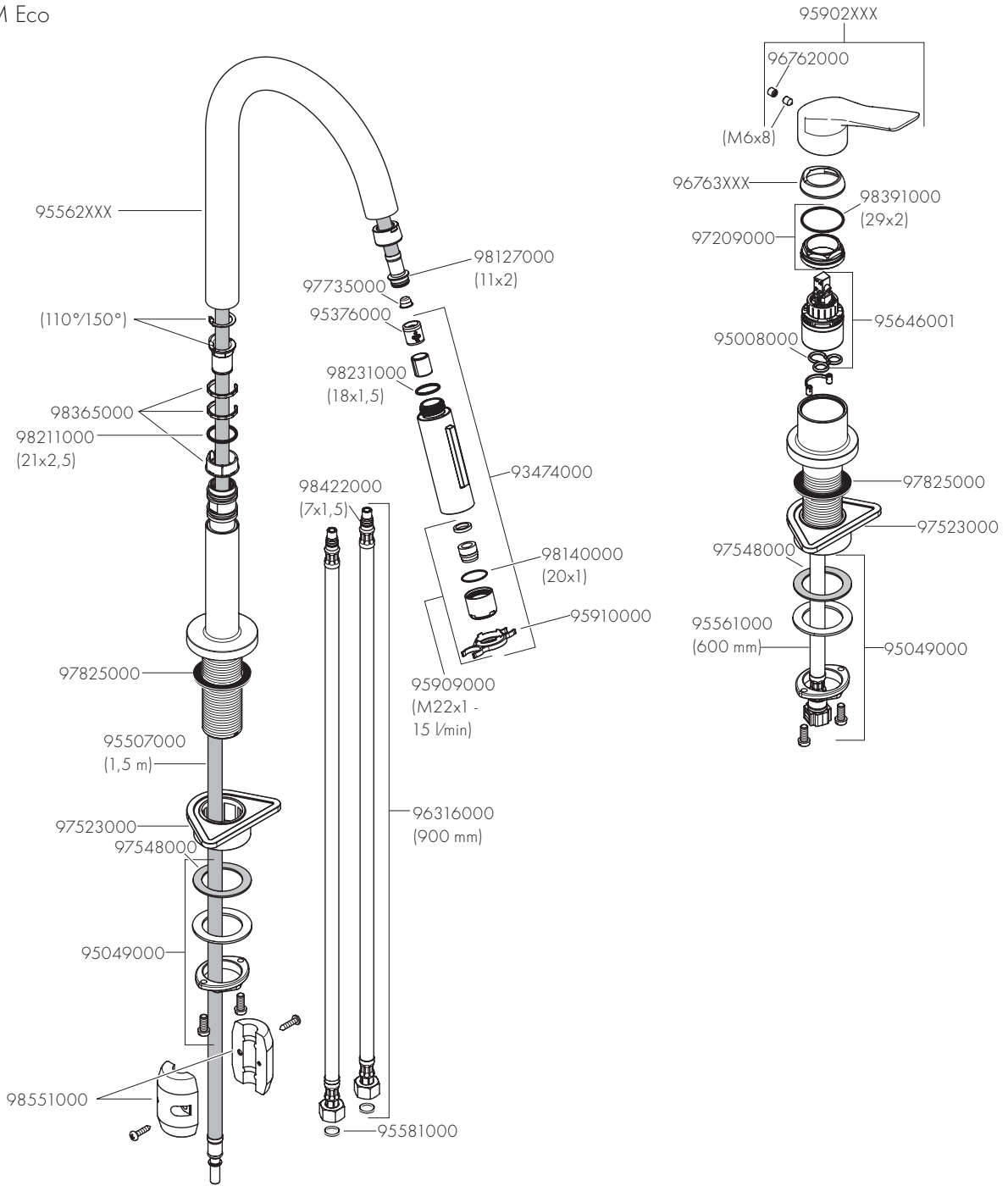

P-IX DVGW SVGW WRAS KIWA NF ACS ETA



34822XXX P-IX 19705/100

X **va** 1.42/20146

1432





DE / Reinigungsempfehlung/Garantie/Kontakt  
 FR / Recommandation pour le nettoyage/Garanties/Contact  
 EN / Cleaning recommendation/Warranty/Contact  
 IT / Raccomandazione di pulizia/Garanzia/Contatto  
 ES / Recomendaciones para la limpieza/Garantía/Contacto  
 NL / Aanbevelingen inzake reiniging/Garantie/Contact  
 DK / Rensning, anbefaling/Garanti/Kontakt  
 PT / Recomendações de limpeza/Garantia/Contacto  
 PL / Zalecenie dotyczące pielęgnacji/Gwarancja/Kontakt  
 CS / Doporučení k čištění/Záruka /Kontakt  
 SK / Odporúčania pre čistenie/Záruka/Kontakt  
 ZH / 清洁指南 / 担保 / 接触  
 RU / Рекомендации по очистке/Гарантия/Контакты  
 HU / Tisztítási tanácsok/Garancia/érintkezés  
 FI / Puhdistussuositus/Takuu/Kosketus  
 SV / Rengöringsrekommendationer/Garanti/Contacto  
 LT / Valymo rekomendacijos/Garantija/Kontaktai  
 HR / Preporuke za čišćenje/Garancija/Kontakt  
 TR / Temizleme önerisi/Garanti/Temas  
 RO / Recomandări pentru curățare/Garanție/Contact  
 EL / Σύσταση καθαρισμού/Εγγύηση/επαφή  
 SL / Priporočilo za čiščenje/Garancija/Kontakt  
 ET / Puhastussuovitused/Garantii/Kontakti  
 LV / Tīrīšanas ieteikumi/Garantija/Kontakti  
 SR / Preporuke za čišćenje/Garancija/Kontakt  
 NO / Anbefaling for rengjøring/Garanti/Kontakt  
 BG / Препоръка за почистване/Гаранция/Контакт  
 SQ / Këshilla rreth pastrimit/Garancia/Kontakt  
 KO / 세정시 권장사항/품질보증/접촉  
 AR / توصيات التنظيف/الضمان (الولايات المتحدة الأمريكية)/اتصال

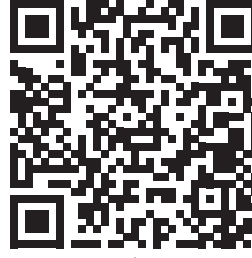

[www.axor-design.com/cleaning-recommendation](http://www.axor-design.com/cleaning-recommendation)

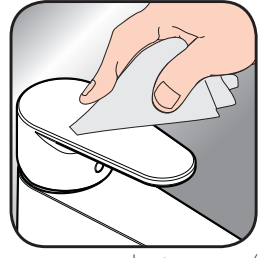

[www.axor-design.com/cleaning-recommendation](http://www.axor-design.com/cleaning-recommendation)



[www.axor-design.com/cleaning-recommendation](http://www.axor-design.com/cleaning-recommendation)



[www.axor-design.com/cleaning-recommendation](http://www.axor-design.com/cleaning-recommendation)

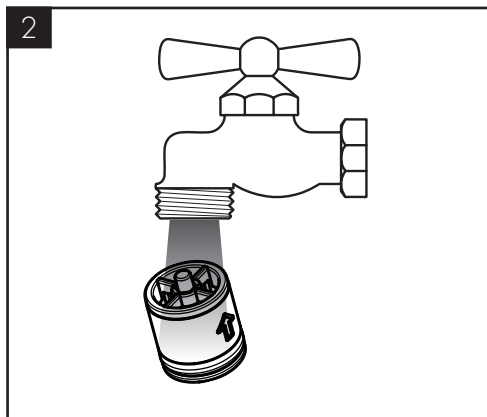
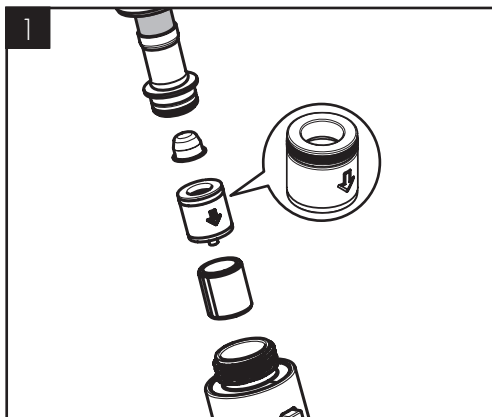
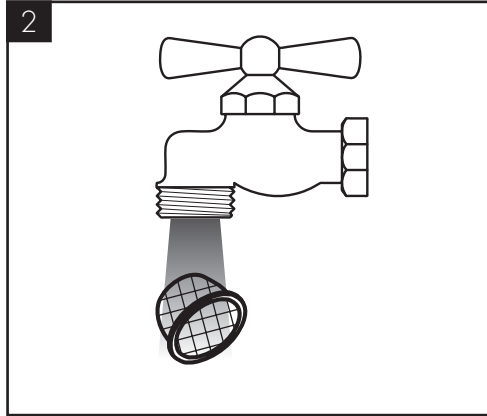
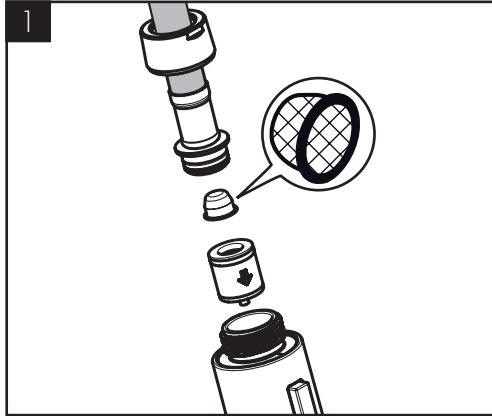



# AXOR

AXOR / Hansgrohe SE  
Austraße 5-9  
77761 Schiltach  
Deutschland

[info@axor-design.com](mailto:info@axor-design.com)  
[axor-design.com](http://axor-design.com)

01/2019  
9.01799.06