

Edition 90

59002010000 Single lever basin mixer 150

PRODUCT



DRAWING

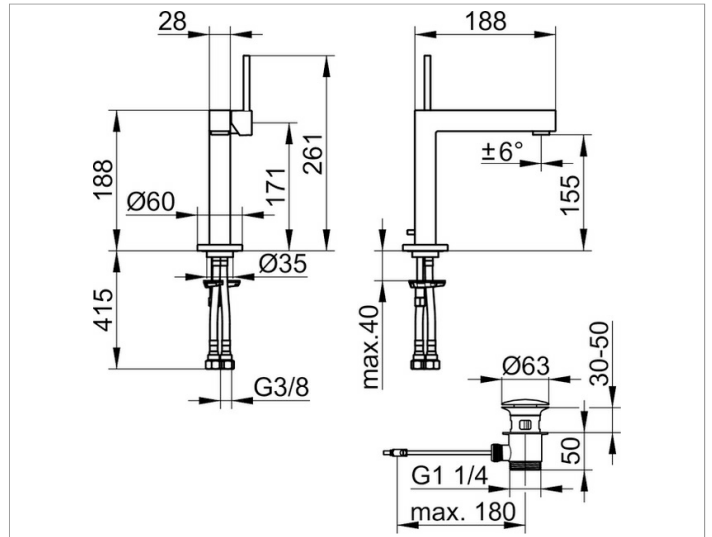

PRODUCT ATTRIBUTES

with pop-up waste 1 1/4 inch,
single hole installation,
cartridge with ceramic discs,
aerator M 24x1, adjustable,
pressure hoses 435 mm, G 3/8 inch
flow rate reduced to 7,6 l/min.

SURFACE

chrome-plated