

Plan Care

34903010737 Drop down supporting rail for WC

PRODUCT



DRAWING

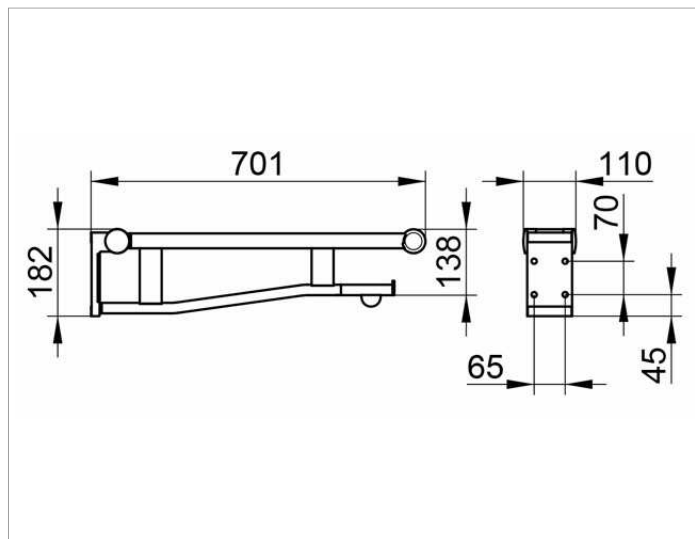

PRODUCT ATTRIBUTES

with synthetic covered support,
movable to vertical position,
with removable toilet paper holder (with roll brake)

SURFACE

chrome-plated/dark grey (RAL 7021)

DIMENSION

700 mm

SPECIFICATIONS

KEUCO PLAN Pivoted supporting rail for WC 34903010737

High shine chrome-plate pivoted supporting rail for WC
with Plastic covered Surface area
in esthetic, practical and ergonomic Design
with synthetic covered support, dark-grey (RAL 7021),
movable to vertical position, braked version
with removable toilet paper holder (with roll brake)
anti-static

Width Surface area with anti-slip,
elegant,
tactile and optical contrasting Handle
Underneath as Hand towel holder useable

Projection 700 mm
Width Wall plate 110 mm,
Height Wall plate 182 mm
Load capacity up to 100 kg
The Handle is Type approved
Wall support grip will be at 4 places discretely mounted

It's essential for installation to order the correct
screws/bolts depending on type of wall:

2 x Mounting-Set 2 (item no. 34991000100) or
2 x Mounting-Set 5 (item no. 34991000200) or
2 x Mounting-Set 8 (item no. 34994000200) or
1 x Mounting-Set 10 (item no. 34996000100)

Please order separately!