

Plan
32998ZZ0002 Base support

PRODUCT

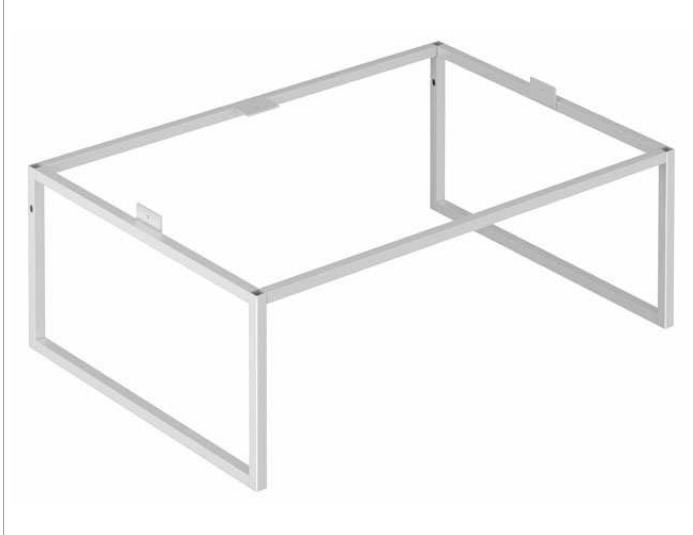

DRAWING

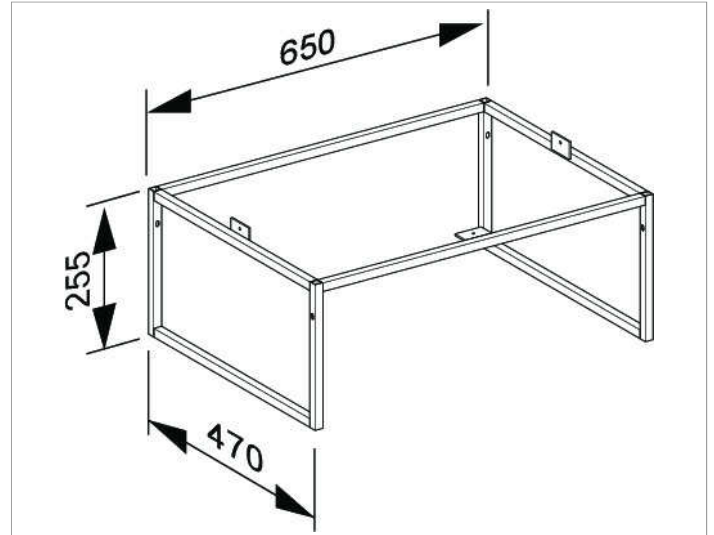

PRODUCT ATTRIBUTES

Steel frame lacquered,
with integrated height compensation (+/- 5 mm),
suitable for vanity unit article no. 32952
and sideboard article no. 32925

SURFACE

11, 14, 18, 29, 30

DIMENSION

650 x 255 x 470