

Plan
32998ZZ0004 Base support

PRODUCT

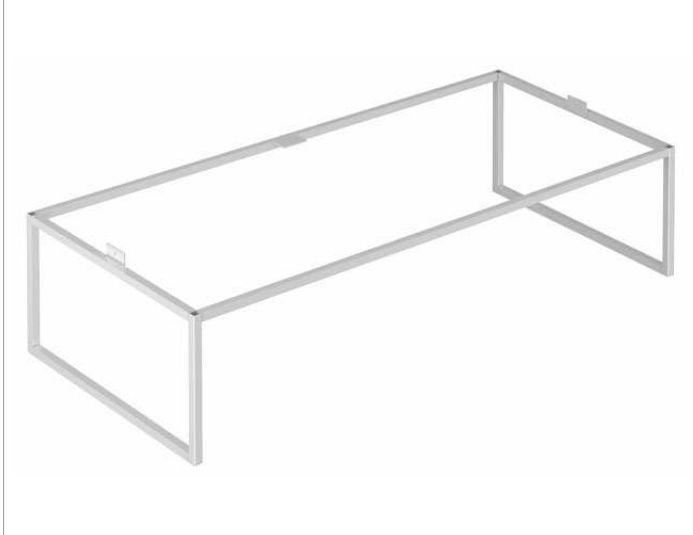

DRAWING

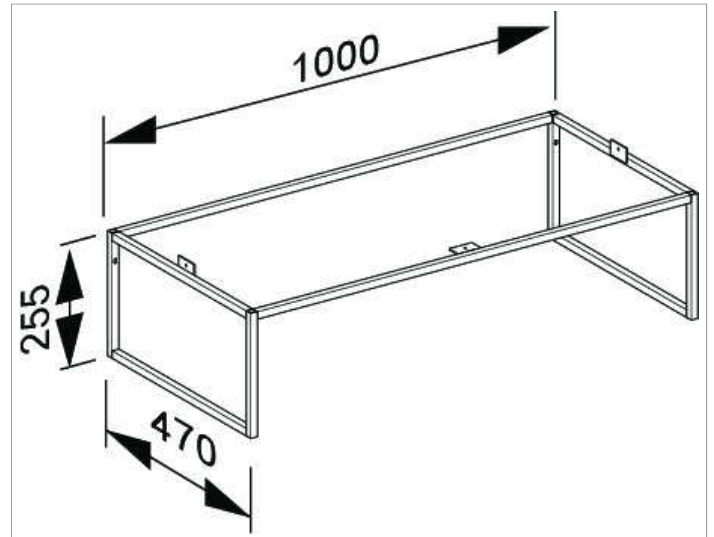

PRODUCT ATTRIBUTES

Steel frame lacquered,
with integrated height compensation (+/- 5 mm),
suitable for vanity unit article no. 32972
and sideboard article no. 32927

SURFACE

11, 14, 18, 29, 30

DIMENSION

1000 x 255 x 470