

MIRROR HOMMAGE

PRODUCT INFORMATION

1 . POSITION



Model	856521
Collection	Hommage
PROJECTS	 PREMIUM
Width	685 mm
Height	740 mm
Weight	11 kg
description	Glass fastening set included
material	Glass
Specification texts	Hommage; Mirror; Glass; Size: 685 x 740 mm; fastening set included

COLOURS

85652100 4051202491390

TECHNICAL DRAWINGS

856521

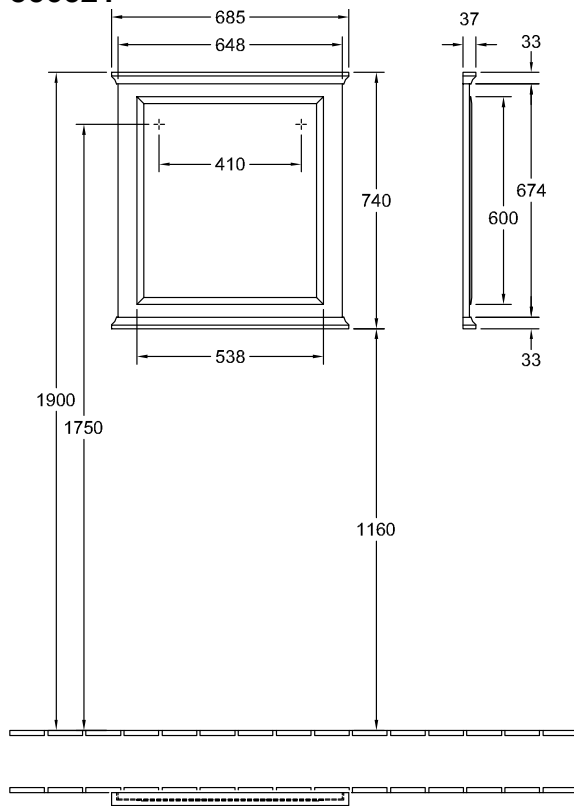

TECHNICAL DRAWINGS

856521

