

Date:

Client:

Project:

VOLA product: 4921

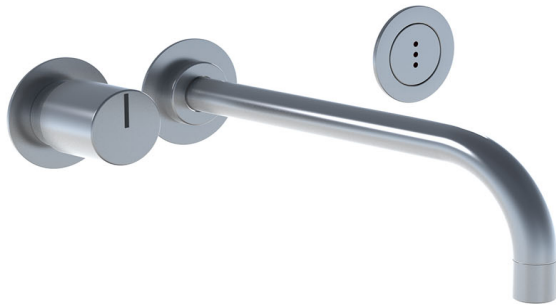

4921

Build-in basin mixer with on-off sensor for 'hands free' operation. Sensor aligned with wall. Valve box VR2618 included. 4921UP = Mixer 4900, sensor cable VR509. 4921AP = Handle NR41, sensor VR510, 225 mm spout Ø20, 60 mm circular flange 001, 3001, VR512.

Ada approved.

Flow

	Bar:	1.0	2.0	3.0	4.0	5.0
4921	(l/min)	2.9	4.1	5.0	5.0	5.0
4921 ¹⁾	(l/min)	2.6	3.7	4.5	4.5	4.5

¹⁾ USA Standard

Available in colors

- Color 02, Grey
- Color 04, Light blue
- Color 05, Orange
- Color 06, Light green
- Color 08, Yellow
- Color 09, Dark grey
- Color 12, Mocca
- Color 14, Bright red
- Color 15, Dark blue
- Color 16, Polished chrome
- Color 17, Gloss black
- Color 18, White
- Color 19, Natural brass
- Color 20, Brushed chrome
- Color 21, Carmine red
- Color 25, Pink
- Color 27, Matt black
- Color 40, Brushed stainless steel

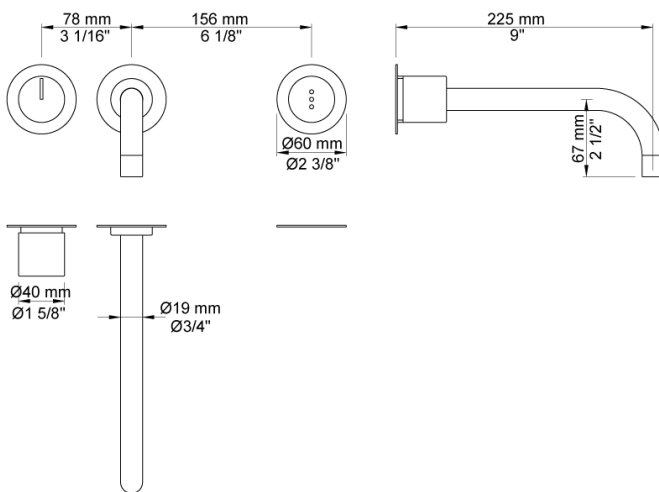

Date:

Client:

Project:

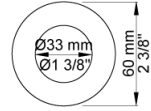
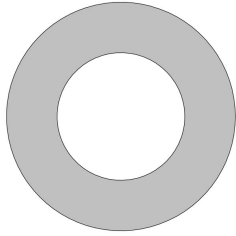

001
60 mm circular flange. Hole Ø33 mm.

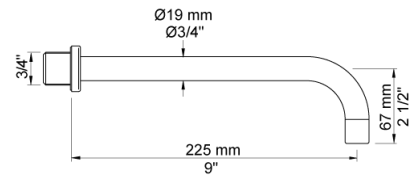

020
225 mm fixed spout with water saving aerator.

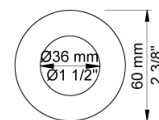

3001
60 mm circular flange. Hole Ø36 mm.

Date:

Client:

Project:

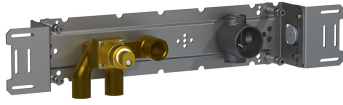

4900
Build-in basin mixer with on-off sensor for 'hands free' operation, with temperature regulation. Valve box for electronic mixer, VR2618 enclosed.

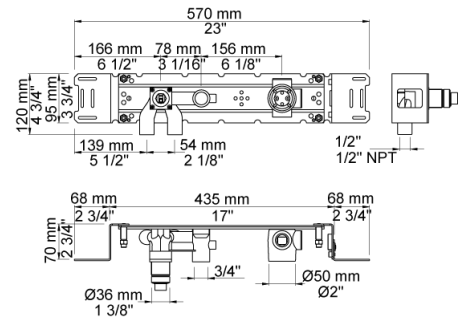

NR41
Temperature control handle for wall-mounted electronic mixer 4100.

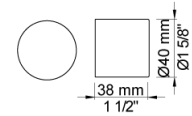

VR2618
Box for Electronic HV1E/4100/4900

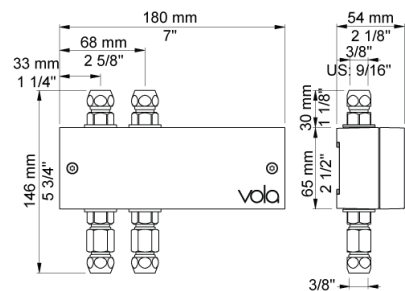

Date:

Client:

Project:

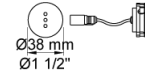
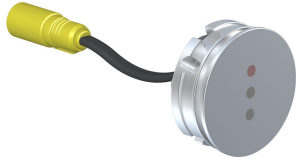

VR510

Sensor for electronic tap 4300, 4800 and 4900.

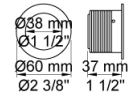
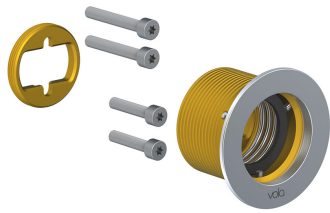

VR512

60 mm circular flange. Hole Ø38 mm for 4300, 4800 and 4900.