

Date:

Client:

Project:

VOLA product: 4911VSX



4911VSX

Build-in basin mixer with on-off sensor for 'hands free' operation. For vertical mounting. Sensor aligned with wall. Valve box VR2618 included. 4911VSXUP = Mixer 4900VSX, sensor cable VR509. 4911VSXAP = Handle NR41, sensor VR510, 160 mm spout 010, 60 mm circular flanges 001, 3001, VR512.

Ada approved.

Flow

	Bar:	1.0	2.0	3.0	4.0	5.0
4911VSX	(l/min)	2.9	4.1	5.0	5.0	5.0
4911VSX ¹⁾	(l/min)	2.6	3.7	4.5	4.5	4.5

¹⁾ USA Standard

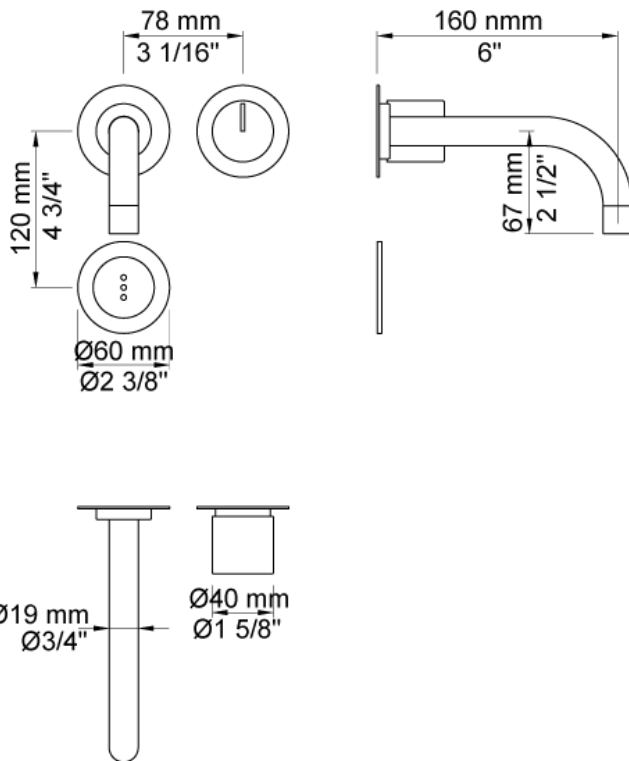

Available in colors

- Color 02, Grey
- Color 04, Light blue
- Color 05, Orange
- Color 06, Light green
- Color 08, Yellow
- Color 09, Dark grey
- Color 12, Mocca
- Color 14, Bright red
- Color 15, Dark blue
- Color 16, Polished chrome
- Color 17, Gloss black
- Color 18, White
- Color 19, Natural brass
- Color 20, Brushed chrome
- Color 21, Carmine red
- Color 25, Pink
- Color 27, Matt black
- Color 40, Brushed stainless steel

Date:

Client:

Project:

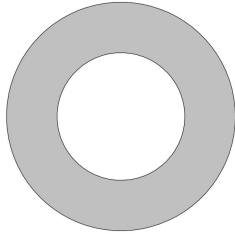

001
60 mm circular flange. Hole Ø33 mm.

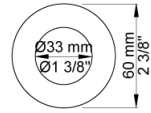

3001
60 mm circular flange. Hole Ø36 mm.

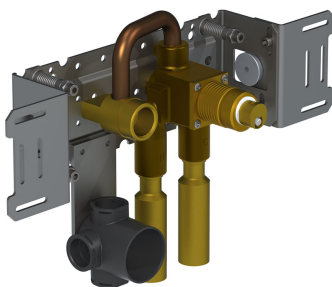
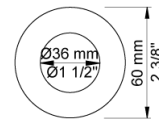

4900VSX
Build-in basin mixer with on-off sensor for 'hands free' operation, with temperature regulation, mixer to the right. Valve box for electronic mixer, VR2618 enclosed.

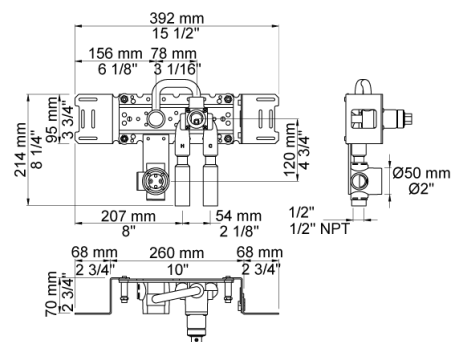

Date:

Client:

Project:

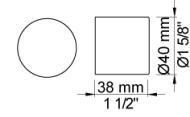

NR41
Temperature control handle for wall-mounted electronic mixer 4100.

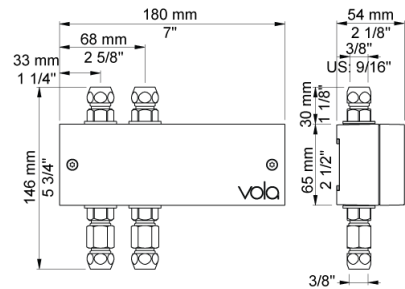

VR2618
Box for Electronic HV1E/4100/4900

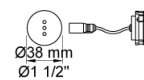
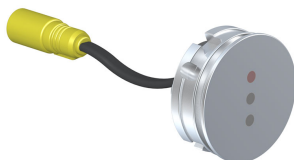

VR510
Sensor for electronic tap 4300, 4800 and 4900.

Date:

Client:

Project:

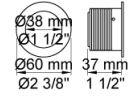
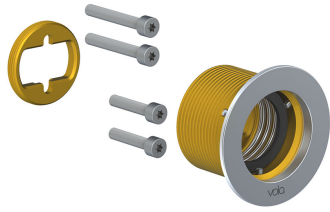

VR512
60 mm circular flange. Hole Ø38 mm for 4300, 4800 and 4900.