

Date:

Client:

Project:

VOLA product: 131M



131M

One-handle build-in mixer with ceramic disc technology. 131MUP = Mixer 100. 131MAP = Handle NR28M, 250 mm double swivel spout 030, 60 mm circular flanges 001, 3001.

Ada approved.

Flow

	Bar:	1.0	2.0	3.0	4.0	5.0
131M	(l/min)	4.8	6.8	8.3	8.3	8.3

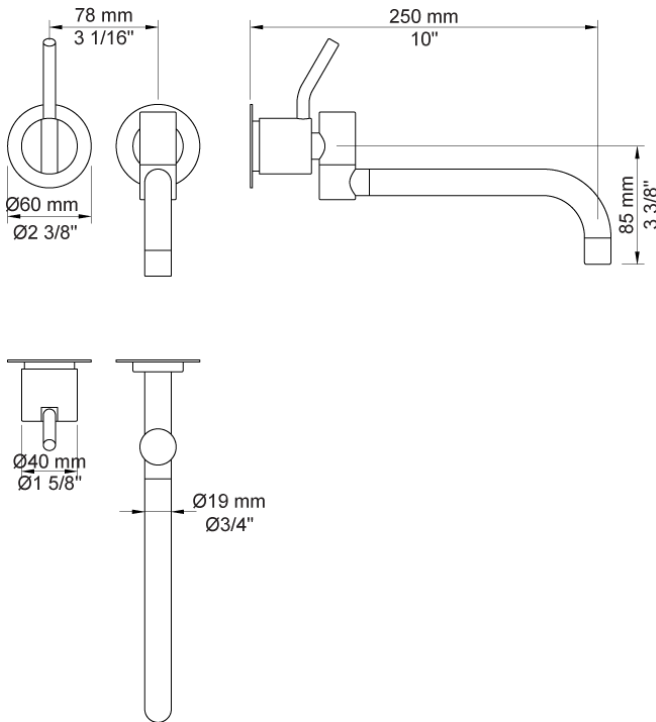

Available in colors

- Color 02, Grey
- Color 04, Light blue
- Color 05, Orange
- Color 06, Light green
- Color 08, Yellow
- Color 09, Dark grey
- Color 12, Mocca
- Color 14, Bright red
- Color 15, Dark blue
- Color 16, Polished chrome
- Color 17, Gloss black
- Color 18, White
- Color 19, Natural brass
- Color 20, Brushed chrome
- Color 21, Carmine red
- Color 25, Pink
- Color 27, Matt black
- Color 40, Brushed stainless steel



Date:

Client:

Project:

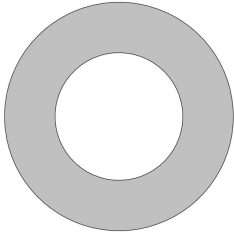

001
60 mm circular flange. Hole Ø33 mm.

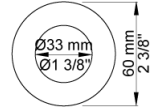

030
250 mm double swivel spout with water saving aerator.

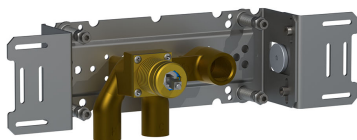
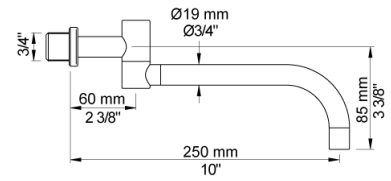

100
One-handle build-in mixer with fixed outlet socket. 1/2" connection to copper, steel, iron or pex pipe work.

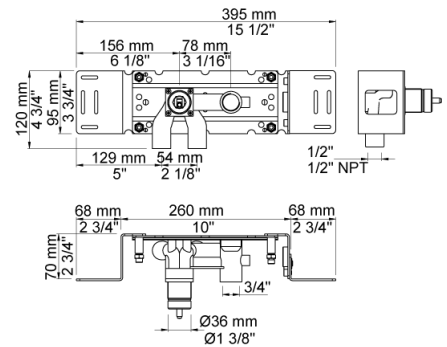

Date:

Client:

Project:

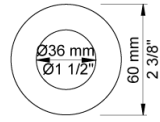

3001

60 mm circular flange. Hole Ø36 mm.

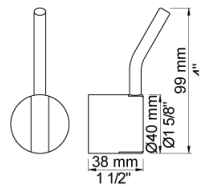

NR28M

Operating handle for 100, 200, 300, 400 incl. variants. Ø40 mm. Medium lever.