

Date:

Client:

Project:

VOLA product: 2471S-061A



2471S-061A

One-handle build-in mixer with ceramic disc technology with diverter. 2471S-061AUP = Mixer 2400N. 2471S-061AAP = Handle NR21, handle NR24G, hand shower and hand holder with non-return valve 070S, hose 1500 mm, ceiling mounted head shower 060A, 4 pcs. 60 mm circular flanges 001, 2001.

Flow

	Bar:	1.0	2.0	3.0	4.0	5.0
070S ¹⁾	(l/min)	6.9	9.8	12.0	13.9	15.5
060A ²⁾	(l/min)	11.6	16.3	20.0	23.1	25.8

¹⁾ USA: Flow restricted to 2.0 gpm (7.6 l/min)

²⁾ USA: Flow restricted to 1.8 gpm (7.0 l/min)

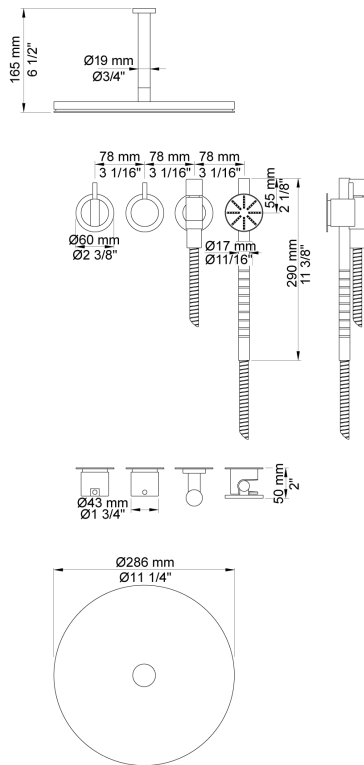

Available in colors

- Color 02, Grey
- Color 04, Light blue
- Color 05, Orange
- Color 06, Light green
- Color 08, Yellow
- Color 09, Dark grey
- Color 12, Mocca
- Color 14, Bright red
- Color 15, Dark blue
- Color 16, Polished chrome
- Color 17, Gloss black
- Color 18, White
- Color 19, Natural brass
- Color 20, Brushed chrome
- Color 21, Carmine red
- Color 25, Pink
- Color 27, Matt black
- Color 40, Brushed stainless steel

Date:

Client:

Project:



001
60 mm circular flange. Hole Ø33 mm.

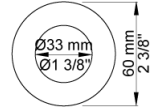

060A
Head shower, round, ceiling-mounted. 60 mm cover flange included.

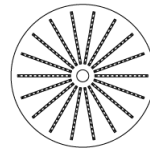
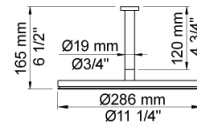

070S
Hand shower, hand shower holder and hose with non-return valve.

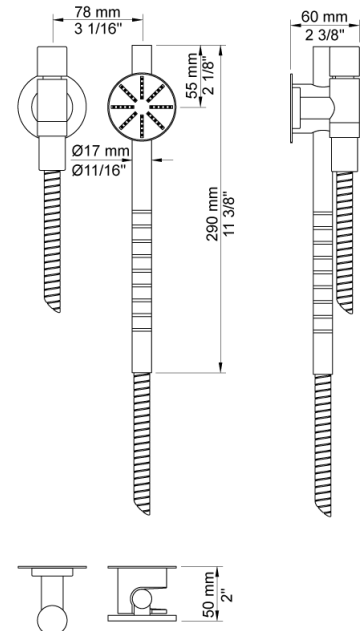

Date:

Client:

Project:



2001
60 mm circular flange. Hole Ø39 mm.

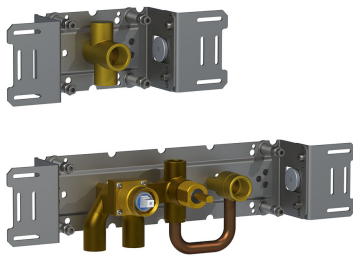
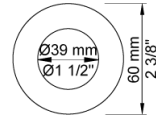

2400N
One-handle build-in mixer for high flow, with diverter, with one premounted outlet socket, and one separate outlet socket, 200M. 1/2" connection to copper, steel, iron or pex pipe work.

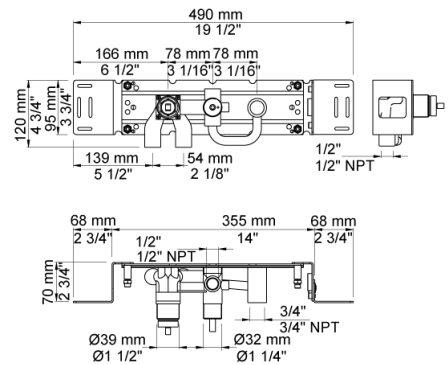

NR21
Operating handle for 2100, 2200, 2300, 2400 incl. variants. Ø43 mm.

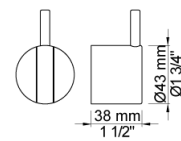

Date:

Client:

Project:

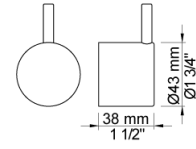

NR24G

Diverter handle for 2400 incl. variants. Ø43 mm. With peg in the same colour as handle (Standard).