

Royal Match
12801171331 Mirror cabinet

PRODUCT

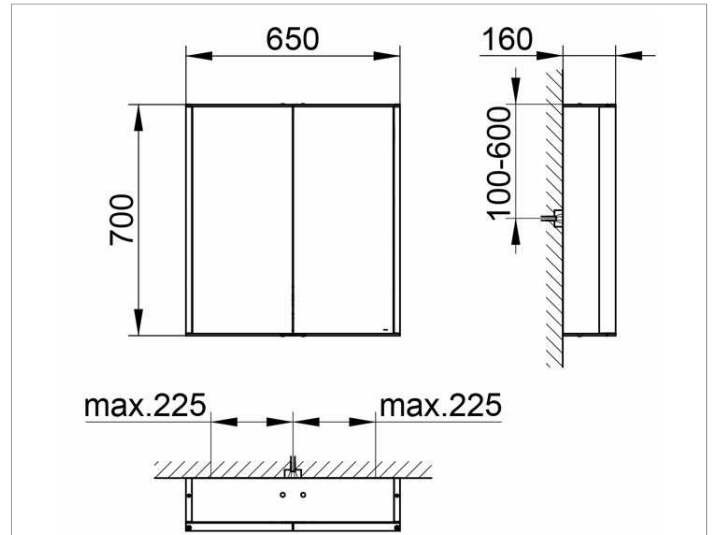

DRAWING



PRODUCT ATTRIBUTES

wall mounted,
 2 hinged double sided crystal mirror doors,
 body in aluminium silver anodized,
 rear panel in back-lacquered white glass
 Operation:
 control panel with capacitive touch sensor,
 optional to be operated via the light switch
 Illumination:
 LED 2 x 12,5 watt (lifespan > 30.000 hours),
 light colour 3000 kelvin (warm white),
 infinitely dimmable, lamps non-exchangeable
 EEK: A++, A+, A , 25 kWh/1000h

EQUIPMENT

- 1 shaver socket (internal)
- 2 x 3 adjustable glass shelves
- interior lighting

SURFACE

silver anodized

DIMENSION

650 x 700 x 160 mm