

Edition 90

59027010100 Single lever bath tub mixer

**PRODUCT**



**DRAWING**

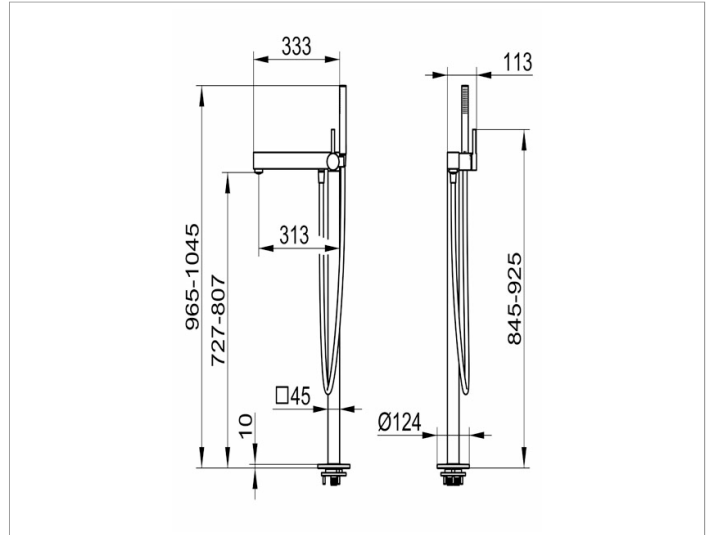

**PRODUCT ATTRIBUTES**

floor-mounted/free standing,  
 cartridge mixer with ceramic sealing gaskets,  
 with aerator, complete with hand held rod shower head  
 and shower hose 1250 mm

**SURFACE**

chrome-plated